

75 cents

*hr*_{mc}

focus
on
communications
technology . . .

ham radio

magazine

AUGUST 1973

3 2 1 0 1 2 3 4 kHz

10
dB

20

30

40

solid-state
phasing-type
ssb

COMMUNICATIONS
RECEIVER

this month

- high-gain log-periodic 18
- fm base station 22
- 1296-MHz noise generator 46
- frequency synthesizer 50

Savoy

BASSETT

High efficiency mobile and portable antennas for all amateur bands, CAP, MARS, CB, SECURITY, PUBLIC SERVICE, MARINE, AND GOVERNMENT USE.

- 2-6-10-15-20-40-75
- Identical size, cost, and appearance
- FULLY ADJUSTABLE TO FREQUENCY IN FIELD
- Low weight, low drag, high strength fiberglass
- Polished chrome brass standard 3/8-24 thread
- High gain collinear on 2 meters

MODEL DGA-2M
\$29.50 postpaid
in U.S.A.



\$3.75

Postpaid in U.S.A.

TYPE 900 A

TYPE 901



HIGH ACCURACY CRYSTALS FOR OVER 30 YEARS

Either type for amateur VHF in Regency, Swan, Standard, Drake, Varitronics, Tempo, Yaesu, Galaxy, Trio, Sonar, Clegg, SBE, Genave.

Quotes on request for amateur or commercial crystals for use in all other equipments.

Specify crystal type, frequency, make of equipment and whether transmit or receive when ordering.



BASSETT VACUUM TRAP ANTENNA SYSTEM

Complete packaged multi-band antenna systems employing the famous Bassett Sealed Resonators and Balun from which air has been removed and replaced with pure helium at one atmosphere. Operating bands are indicated by model designation.

MODEL DGA-4075	...	\$59.50
MODEL DGA-204075	...	\$79.50
MODEL DGA-2040	...	\$59.50
MODEL DGA-152040	...	\$79.50

BASSETT VACUUM BALUN



The famous sealed helium filled Balun . . . employed with the DGA Series Antenn Systems. Solderless center insulator an easily handles more than full legal power while reducing unwanted coax radiator. Equipped with a special SO-239 type coax connector and available either 1:1 or 4:1

MODEL DGA-2000-B . . . \$12.95
Postpaid in U.S.A.

CONTACT YOUR DISTRIBUTOR OR WRITE FOR DATA

Savoy Electronics, Inc.

P.O. Box 7127 - Fort Lauderdale, Florida - 3330

Tel: 305-566-8416 or 305-947-1191



HOW RELIABLE IS AN **ALPHA 77**?



ETO's FACTORY WARRANTY PROVIDES A HINT . . .

**IT'S AN UNPRECEDENTED FULL YEAR ON
EVERYTHING AND TWO YEARS ON THE TRANSFORMER**

HERE ARE SOME *MORE SPECIFIC* FACTS:

In the first full year of production, *ALPHA 77's* suffered a total of . . .

- *NO* high voltage power supply failures
- *NO* bandswitch or tank circuit failures
- *NO* cooling system failures
- *NO* significant damage in shipment

Those results speak louder than any specification. Of course an occasional problem does arise, and then we do everything feasible to help get it corrected *fast*. Ask an owner . . . *if you can find one who's needed service.*

For detailed literature telling the inside story of the *ALPHA 77*, write or phone. Model PA-77, \$1995.



EHRHORN TECHNOLOGICAL OPERATIONS, INC.
BROOKSVILLE, FLORIDA 33512
(904) 596-3711



"THE ONE FOR THE ROAD"

...SWAN'S MONOBANDER

Here they are. Your choice of two high quality, fully solid-state, all American made Monobanders. Especially styled and engineered for mobile operation, these handsome units are just 3" high x 8½" wide x 9" deep with a built-in speaker. Completely designed and manufactured by SWAN ELECTRONICS, these new single sideband transceivers feature the very latest practical engineering state-of-the-art developments in amateur radio equipment.

- No tune-up time required
- Operate directly from 12V DC
- SSB and CW modes
- Transmit ALC
- Virtual elimination of front-end overload, distortion and cross-modulation
- No transmitter tuning
- 15 Watts P.E.P. input
- S-Meter
- Smooth AGC

... PLUS ... infinite VSWR protection from an open to a short circuit!

• Simply connect the Monobander to any 12V DC source and antenna, plug in your mike or key, flip on the power switch and you're on the air!

Select the SWAN MB-40 for 7.0 to 7.3 MHz or the SWAN MB-80 for 3.5 to 4.0 MHz. Whichever you choose, the cost is right-on at \$249.95 and your investment is backed by SWAN's warranty and service program that has built a reputation for quality unequalled by any other manufacturer of amateur radio products.

Don't miss out on the exciting world of mobile communications. Order your SWAN MONOBANDER, now. Make it your "One" for the road.

To order your Monobander, complete this coupon and mail to:



SWAN
ELECTRONICS
A subsidiary of Cubic Corporation

305 Airport Road, Oceanside, CA 92054

Gentlemen:

H873

Send me "One" for the road as indicated. MB-40 MB-80

\$249.95 enclosed, I'll pay shipping C.O.D.

\$25 enclosed, charge the remainder to my SWAN Revolving Credit Service account # _____

Ship C.O.D. Please send me a SWAN Credit Application form.

Name: _____ Radio Call: _____

Address: _____

City: _____ State: _____ Zip: _____

August, 1973
volume 6, number 8

staff

James R. Fisk, W1DTY
editor

Patricia A. Hawes, WN1QJN
editorial assistant

Nicholas D. Skeer, K1PSR
vhf editor
J. Jay O'Brien, W6GDO
fm editor

Alfred Wilson, W6NIF
James A. Harvey, WA6IAK
associate editors

Wayne T. Pierce, K3SUK
cover

T.H. Tenney, Jr. W1NLB
publisher

Hilda M. Wetherbee
assistant publisher
advertising manager

offices

Greenville, New Hampshire 03048
Telephone: 603-878-1441

ham radio magazine is
published monthly by
Communications Technology, Inc
Greenville, New Hampshire 03048

Subscription rates, world wide
one year, \$7.00, three years, \$14.00
Second class postage
paid at Greenville, N.H. 03048
and at additional mailing offices

Foreign subscription agents
United Kingdom
Radio Society of Great Britain
35 Doughty Street, London WC1, England

All European countries
Eskil Persson, SM5CJP, Frotunagrand 1
19400 Upplands Vasby, Sweden

African continent
Holland Radio, 143 Greenway
Greenside, Johannesburg
Republic of South Africa

Copyright 1973 by
Communications Technology, Inc
Title registered at U.S. Patent Office
Printed by Wellesley Press, Inc
Framingham, Massachusetts 01701, USA

ham radio is available to the blind
and physically handicapped on magnetic tape
from Science for the Blind
221 Rock Hill Road, Bala Cynwyd
Pennsylvania 19440
Microfilm copies of current
and back issues are available
from University Microfilms
Ann Arbor, Michigan 48103

Postmaster: Please send form 3579 to
ham radio magazine, Greenville
New Hampshire 03048



contents

6 phasing-type communications receiver
G. Kent Shubert, WAØJYK

18 high-gain log-periodic antenna
George E. Smith, W4AEO

22 two-meter fm base station
A. E. Ericson, W9JTQ

30 television dx
Morrie S. Goldman, WA9RAQ

40 selecting batteries
John R. Nelson, WBØAIK

46 1296-MHz noise generator
C. L. Dirickson, W3BSV

50 two-meter frequency synthesizer
James D. Fahnstock, WØOA

4 a second look	62 ham notebook
94 advertisers index	64 new products
58 comments	94 readers service
85 flea market	

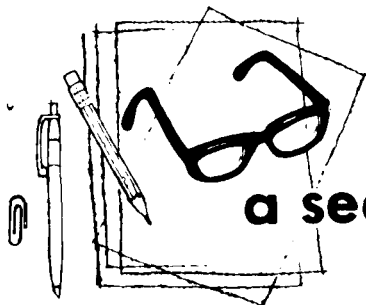

a second look

by jim
fisk

From all indications, it looks like there's a good possibility that we're going to lose the top 1 MHz of the amateur 220-MHz band to make way for a new Citizens Radio Service. Although this new CB service was originally proposed over two years ago by the Electronic Industries Association, the wheels of government grind ever so slowly, and it wasn't until early June that the FCC released their Docket 19759, proposing the creation of a new 224-225 MHz Class-E Citizens Radio Service. Comments are invited from interested parties (the usual original and 14 copies) before September 20, 1973.

According to a spokesman at the FCC, it is estimated that the new CB service could be finally approved by the Commission within 6 months to a year. The Commission also said that the new 1-MHz Citizens Band would be divided into 40 25-kHz fm channels. Eligibility would be similar to that for the present Class-D service on 27 MHz — any person 18 years or older who meets the basic criteria for licensing.

In proposing the new band, the FCC cited the need for additional frequencies to meet the requirements of the general public for improved radio communications and to relieve some of the heavy concentration of CB stations on the channels available in the 27-MHz band — the 49,000 Class-D licensees of 1959 had grown to nearly 900,000 in 1972.

Obviously, a new radio service such as this creates a huge new market for the electronics industry, and the EIA is pushing hard for early approval. Once the necessary equipment is mass produced, it is expected to sell for about \$200 to \$300 per unit; the EIA estimates that two to three years after the new service is

started, it will represent a new electronics market amounting to some \$300 million annually. That's a lot of boodle!

Since the proposed use of a portion of the 220-225 MHz band for CB would not be in accord with the International Table of Frequency Allocations, objections from Canada and Mexico might require a prohibition against any other operations in some border areas. Until that matter is resolved, mobile stations would not be permitted to operate within ten miles of the border, and base stations would not be permitted within 25 miles of the border.

Although I'm usually an optimist, there appears to be little that amateurs can do to prevent the loss of 224-225 MHz. When a proposal reaches the FCC Docket stage, it is usually approved in one form or another. If you remember the big-bucks EIA steamroller and the nearly one-million CBers clamoring for approval, the new class-E service is practically a foregone conclusion.

However, there's a small, bright side to the picture, too. Since the industry will be geared up to mass produce 225-MHz CB radios, there should be an abundance of gear available for amateur use. 220 has always been one of our little-used bands, essentially an orphan, and the lack of proper equipment has been one of the major stumbling blocks. On the other hand, it would be a simple matter for a proficient CB technician to illegally tweak his type-accepted radio down to the amateur frequencies. Perhaps that's the price of progress.

Never-the-less, the FCC wants to hear your comments. Don't forget the 14 copies.

Jim Fisk, W1DTY
editor

If you like 2 METER . . .

YOU'LL LOVE OUR

ALL NEW
HR-2B
NARROW BAND FM TRANSCEIVER



**15 OR 1 WATT POWER OUT/SWITCH SELECTABLE /
FULL 12 CHANNEL TRANSMIT AND RECEIVE CAPABILITY**

You'll like the crystal clear transmit and receive performance of this compact, 2 meter unit and so will those listening. The 12 transmit channels are provided with individual trimmer capacitors for the optimum in point-to-point and repeater applications. A HI/LO power switch provides 1 watt output or full rated output. The receiver has an audio output of 3 watts at excellent sensitivity. Solid state, American made quality at a low price.

\$229⁰⁰

AMATEUR NET

includes plug-in ceramic mike,
mounting bracket and transmit and
receive crystals for 146.94 MHz.

Regency
the first name in solid state

THE FM LEADER IN 2 METER AND 6 METER . . . AND NOW 220 MHz

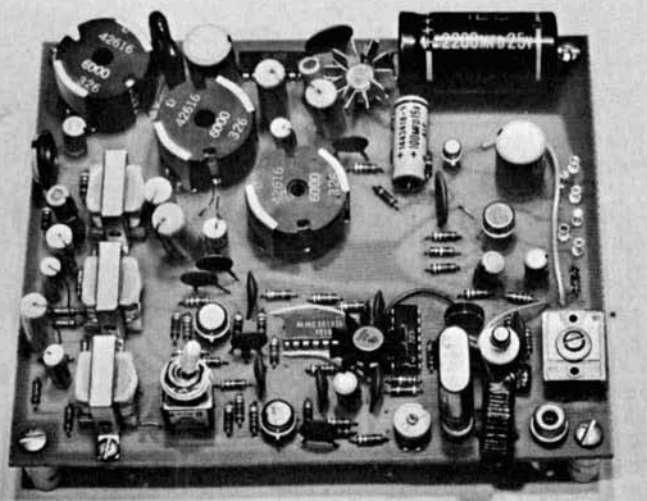

solid-state phasing-type ssb communications receiver

The Phase II Receiver —
a state-of-the-art
phasing-type receiver
for high-frequency
ssb communications

G.K. Shubert, WAØJYK, 1308 Leevue Drive, Olathe, Kansas 66061

Many amateurs participate in a public service net or a public service program such as MARS, CAP, AREC or RACES. This receiver, which I call the *Phase II Receiver*, was designed to provide economical monitoring of a single net frequency while the station receiver, or transceiver, is free for general hamming. Portable and mobile operation was also considered. The power requirement is 10 to 24 volts, ac or dc, at about 180 mA. Although this is a bit high for flashlight batteries, the design concept required ICs that draw relatively high current.

Crystal-controlled operation provides excellent stability and, since fixed frequency monitoring with high stability was the object, no vfo or frequency synthesizer was included in the initial design. However, it may be added at a future date. Most commercial equipment available to amateurs does not provide the frequency coverage or the stability required for use on MARS or CAP frequencies. It's really great to turn on a cold receiver and be within 10 hertz of the exact frequency — immediately! That is what the *Phase II Receiver* will do.

Direct conversion has been used often for inexpensive receivers but the highly undesirable audio image has been a menace, particularly on crowded bands.^{1,2} Although many of these receivers have been referred to as ssb receivers, that is a complete misnomer. More accurately, they are double-sideband receivers that will copy single-sideband signals providing, of course, that there is no strong interference on the unwanted sideband. Even if there is absolutely no interference there is still a degradation of the signal-to-noise ratio because the receiver bandwidth is twice as wide as the signal.

phasing-type receivers

The phasing-type receiver or, at least, the phasing-type detector is by no means a new technique. The phasing-type transmitter, however, has retained its popularity better than the phasing-type receiver. Excellent explanations of the technique were given by Villard, Thompson and Norgaard in several post-war issues of *QST*.^{3,4} Amateur ssb was in its infancy when those articles were written, and the phasing method of receiving and transmitting was at least as popular as the filtering method — probably more so because it held an economic advantage. Perhaps it still does!

Taylor revived the phasing receiving technique in 1969 and combined phasing with direct conversion.⁵ For those of you with less extensive libraries and for those of you who understand semiconductors better than tubes, the phasing technique and direct conversion receivers were brought up to date by Ed Noll in 1971.⁶

It has been stated that a direct-conversion receiver does not provide single-signal reception.⁷ This is somewhat like saying that a Ford automobile has one-hundred horsepower — a rather senseless generalization. There are quite a few filter-type receivers around that really don't provide single-signal reception either, due to design shortcomings.

I have presented the *Phase II Receiver* and the phasing technique of receiving at

several club meetings and at two Regional Air Force MARS Conferences. It is interesting that the newcomers understand ICs, but some of the old-timers have a much better comprehension of the phasing technique.

To be competitive with receivers that use crystal or mechanical filters, the phasing-type receiver must suppress the unwanted sideband by 40 dB or more. Wade has researched the problem of

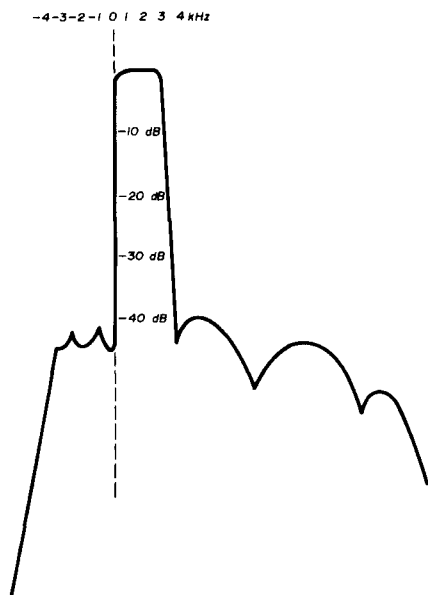

fig. 1. Passband characteristic of receiver for upper sideband reception.

unwanted sideband suppression thoroughly and provided the data in convenient form.⁸ At first glance, the infinitesimal phase and amplitude variations that can be tolerated seem formidable but, modern integrated circuits maintain the amplitude balance, a digital rf phase shifter can be quite accurate, and audio phase shift can be controlled very closely with modern computer-aided designs.

selectivity

The passband shape of a phasing-type receiver is unique. Fig. 1 shows the receiver passband for upper sideband re-

ception. Cancellation of the lower sideband occurs immediately below the suppressed-carrier frequency and the passband shape on the upper side is controlled by the audio-frequency lowpass filter. The effective passband shape factor is better than 1.2:1 at the 40-dB points. A crystal filter with skirts that steep should easily cost more than the whole *Phase II Receiver*. A bandpass filter may be substituted for the audio lowpass filter for the reception of CW or RTTY.

Taylor stated that reception with a

receiver has quite wide bandwidth. Undoubtedly, these conditions will pave the way for the future addition of a digital noise blanker.

A design goal was to provide a versatile receiver module that could function by itself or be integrated into a monitoring or transceiving system. Since the system approach was in mind, very little front-end filtering has been provided on the PC board itself. The board has been drawn to allow the mounting of volume and agc potentiometers directly on the board, but

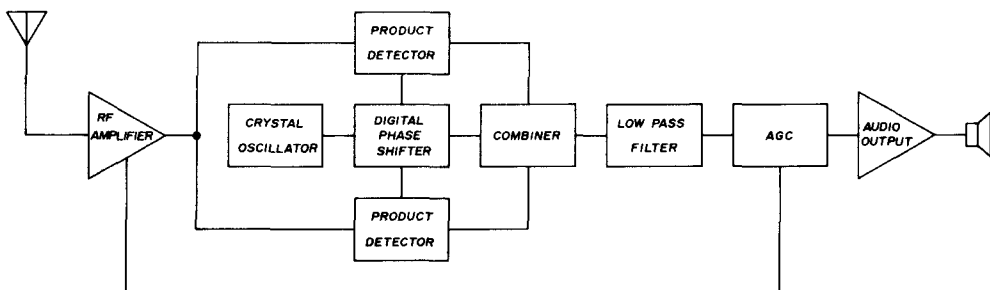

fig. 2. Block diagram of the high-performance phasing-type ssb receiver. The circuit, fig. 3, makes maximum use of integrated circuits.

direct-conversion receiver gives the signal a feeling of "transparency" or "presence."⁵ Impulse noise and atmospheric noise are less objectionable too. Crystal filters and mechanical filters have a very narrow percentage bandwidth with an accompanying high degree of delay distortion. Short pulses applied to this type of filter are severely distorted or stretched. A splendid example of this is to listen to a pulse with a wide filter (a-m type filter) and then listen to the same pulse with a very narrow filter (CW type). A pulse that only causes a click with the wide filter will result in a dull thud with the narrow filter.

The delay distortion of the audio low-pass filter, including the all-pass phase-shifter, is only a small fraction of that found in small percentage bandwidth bandpass filters. The all-pass networks used in the audio phase-shift networks provide a certain amount of time delay of the signal. The signal at this point in the

in most cases panel-mounted pots would probably be more convenient. The complete *Phase II Receiver* is on a 5x6-inch single-sided PC board which is potentially the most valuable 30 square inches of real-estate in my hamshack.*

Primary frequency coverage of the receiver as shown is from 3 to 10 MHz but this range can be extended by changing T1 or by providing a different front-end filter. Sideband suppression is poorer above 10 MHz and reception below 1 MHz may require more inductance at L1.

It is also possible to use the basic receiver for reception of vlf and low-frequency CW and RTTY transmissions. Of course, a-m reception is not very pleasant with no way to turn off the bfo,

*Printed-circuit boards for the Phase II Receiver, drilled and silver plated, are priced at \$8.00 each from CMS Products, 317 NW 82nd Street, Kansas City, Missouri 64118.

so broadcast reception doesn't offer much. Frequency measurement of a received signal is a simple matter with this receiver and more will be mentioned about this later.

rf amplifier

A dual-gate mosfet provides good *agc control and amplification over a wide frequency range with no neutralization*. The mosfet provides wide dynamic range and low cross-modulation but also requires "backward" agc voltages. The agc voltage decreases as received signal strength increases. The single tuned circuit in the front end is an absolute minimum. This single circuit may be adequate for portable operation but operating in a metropolitan area will require some additional filtering to keep out broadcast stations and other local amateurs.

The output stage of a companion-transmitter may provide enough additional filtering. If the receiver is to be used with a transmitter of fairly high power level it might be wise to place protective diodes across the front end circuit. The Motorola MFE3006 transistor is the only one I have tried in the front end but others should work as well or better. Some other transistors might be a little more rugged but my receiver hasn't blown one, even with 100 watts radiating from an adjacent dipole.

product detectors

The signal from the rf amplifier is fed to a pair of identical MC1496 double-balanced mixer ICs used as product detectors. These product detectors have an extremely wide dynamic range and contribute quite a lot to the overall performance of the receiver. Transformer coupling at the outputs of the product detectors provides a low impedance to drive the audio phase-shift networks, attenuating frequencies below about 100 Hz and above 20 kHz or so. The frames of the transformers are grounded and help prevent any rf leakage from the product detectors to the audio combiner.

audio phase-shift networks

The audio phase-shift networks are a pair of four-pole, all-pass, RC networks which track each other with a very precise 90-degree phase difference.⁹ The audio phase shifters in most block diagrams are shown as plus and minus 45 degree phase shifts but, of course, this is never the case in practical networks. It is extremely important to use precision film resistors in these networks to maintain proper phase shift not only initially but to stay put for the years to come.

If portable or mobile operation is contemplated the capacitors in this section should be polycarbonate film; for hamshack use the polyester film types (Mylar) should be adequate. Capacitor tolerance is equally important as the resistor tolerance but 1% capacitors are not a stock item. Even 5% capacitors are a little hard to find. If possible, these capacitors should be bridged or measured but 5% values and a little luck will provide good sideband suppression.

Two jfets provide the audio combining and some amplification with a pot connected between the sources to trim any amplitude imbalance preceding them. The audio phase-shift networks prefer to operate from a zero impedance into an infinite impedance and are not too forgiving of any other conditions. The audio

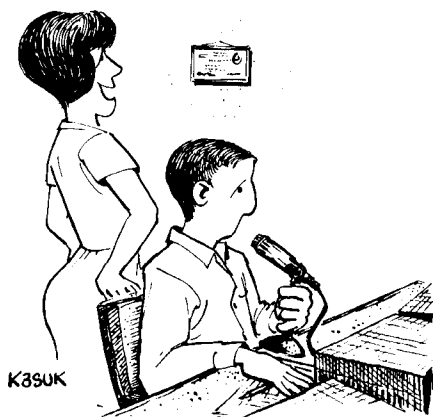

"Hey! How about that. . . your license expired in March of 1969. . ."

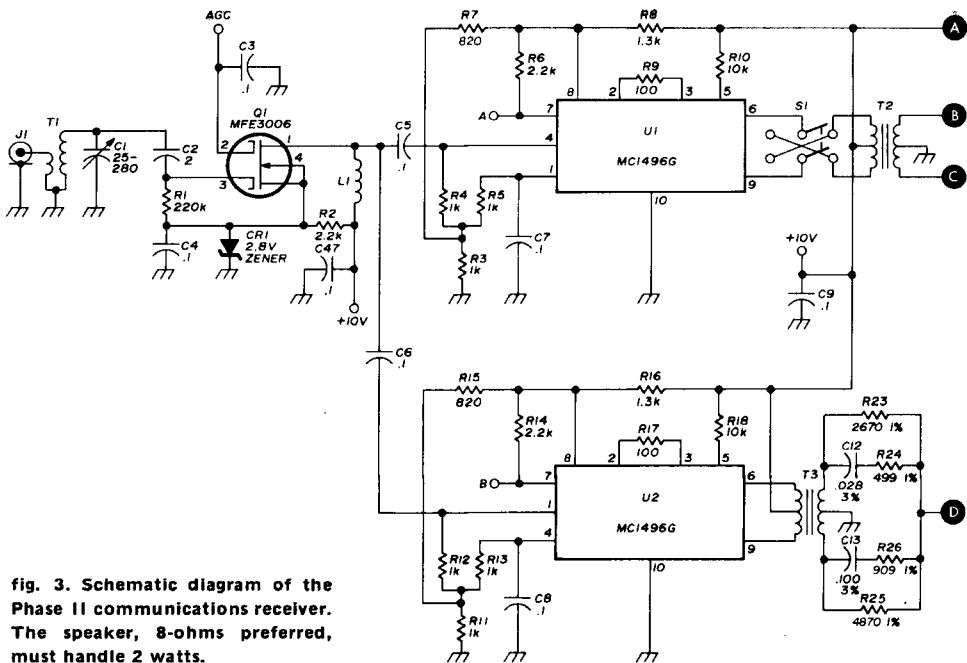

fig. 3. Schematic diagram of the Phase II communications receiver. The speaker, 8-ohms preferred, must handle 2 watts.

combiner uses a transformer for mixing and for impedance conversion to match the 1 kilohm input impedance of the audio lowpass filter.

audio lowpass filter

The audio lowpass filter is an elliptic

function type design providing three attenuation peaks in the stopband and a cutoff frequency of 2.8 kHz. The filter has been computer "juggled" to permit the use of surplus 88-mH loading coils while retaining the best possible performance. Several receivers I have built used

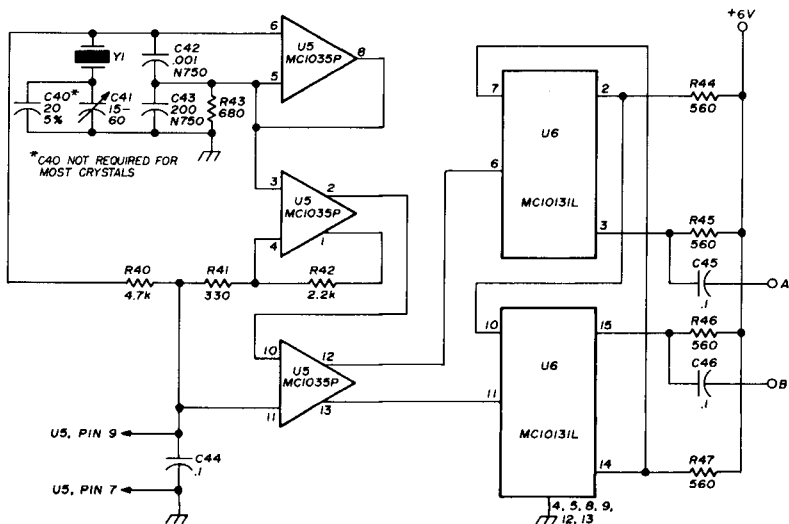

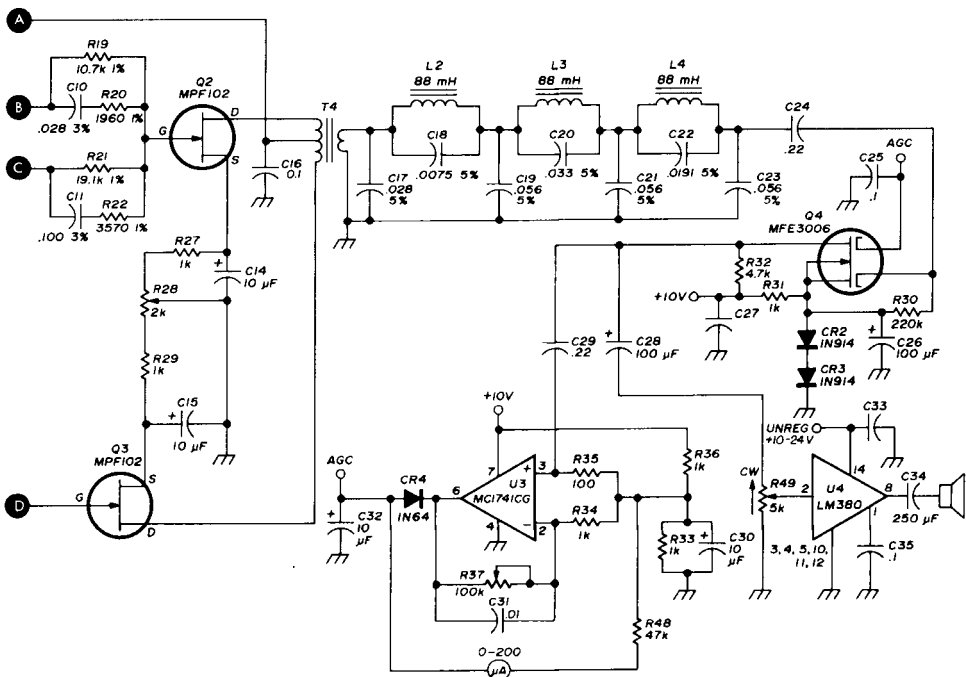

- | | | | |
|-----|--|----------|---|
| L1 | rf choke, 40 turns no. 34 on C40304TC core | R49 | 5000-ohm pot, PC mounting (Mallory MTC-53L1) |
| L2 | 88-mH toroid, tuned to 6180 Hz with C18 | S1 | PC-mounting dpdt switch (ALCO MSTA-206N) |
| L3 | 88-mH toroid, tuned to 3340 Hz with C20 | T1 | secondary, 40 turns no. 24; primary, 2 turns no. 24 on Amidon T68-6 core (for 3 - 10 MHz) |
| L4 | 88-mH toroid, tuned to 3815 with C22 | T2,T3,T4 | 3:1 miniature audio transformer* |
| R28 | 2000-ohm pot, PC mounting (Mallory MTC-23L1) | Y1 | fundamental crystal operated at twice desired frequency |
| R37 | 100k pot, PC mounting (Mallory MTC-15L1) | | |

ferrite pot cores (Ferroxcube 2616 A1 400 3b9) but the slight bit of improvement is not worth the additional cost. The PC board is designed to accept either the toroidal loading coils or the pot-core assemblies. A 10% variation in the value of the capacitors will not make any noticeable difference to the ear.

This filter determines the passband shape and stopband performance of the receiver to a large degree. For those hardy souls who "roll their own" and wish to tailor a filter to suit some particular need, the three articles by Wetherhold will help lead the way.^{10,11,12}

The input impedance to the filter is nominally 1000 ohms and the load is

nearly 1 megohm. Active filters have been tried but, in this degree of complexity, are far too expensive, consume power, and are temperamental. Active filters generally require both positive and negative power supplies but the National LM 3900 quad-op amp IC may provide some relief for this problem.

Bandpass filters may be used for reception of CW and RTTY and some modification of the agc constants might be desirable too. It is also possible to derive afc voltage from the RTTY term-

*The set of three transformers is available from the author for \$10.00, postpaid.

inal unit and feed it back to a voltage-variable capacitor across the crystal. Why not integrate the receiver right into the terminal unit? This is very handy for autostart operation.

audio-derived agc

Audio-derived agc is about the only means of agc available in a direct-conversion receiver. As mentioned earlier, the agc voltage is reversed because the agc control elements are two mosfets. One in the rf amplifier and another following the lowpass filter in the audio section. A 741-type operational amplifier provides the amplification for the agc independently of most of the speaker audio amplification. The response of this amplifier is modified with a feedback capacitor to slightly delay the attack time and prevent agc hangup on noise spikes.

The coupling capacitor to the agc amplifier is small to prevent response to very low frequencies. The information to be copied by an ssb receiver is a human voice and the object is to tailor the agc response to the voice and minimize response to undesired signals. A very broad peak at about 700 Hz is desirable. The amplifier pulls down the agc voltage quite rapidly and a resistor in series with the S-meter recharges a capacitor providing hand operation.

audio output amplifier

The audio output stage is one of the newer consumer products on the market, the National LM380 IC, 2-watt audio amplifier. This IC outperformed several other ICs and modules that were tried. It is very stable electrically, convenient mechanically, almost indestructible and, most important, inexpensive.

crystal oscillator and digital phase-shifter

Direct-conversion receivers of years past suffered from a lack of operational bandwidth. Some form of LC phase shifter covering a hundred kilohertz or so was considered broadband several years ago.⁵ Digital phase shifters or quadrature gener-

ators are not new but this one requires only a frequency division by two rather than the more conventional division by four.¹³

A single inexpensive IC, a Motorola MC1035P, provides a crystal oscillator, a Schmitt trigger and a differential output amplifier.* The differential square-wave outputs from this stage are at the crystal frequency and, of course, 180 degrees out of phase. These square waves are divided by two in a switch-tail ring-counter which also provides synchronization to the phase quadrature, regardless of turn on or turn off of the receiver. One prototype receiver I built had no synchronizing circuitry and had a nasty habit of randomly choosing its own sideband.

This digital phase-shifter requires extremely fast, well matched ICs. The receivers built before the availability of the MC10131L just did not perform at 10 MHz with more than 20 dB of unwanted sideband suppression. Perhaps a faster IC will appear on the market which will permit operation to even high frequencies but the MC1496 ICs are also a limitation. Since it is nearly impossible to test the rf phase-shifter with conventional test equipment the performance of the overall receiver is the only practical test. The MC10131L IC is not cheap, and it draws a lot of current, but it is the key that unlocks the door to broadband operation.

The crystals are standard fundamental types for 32-pF operation. The PC board has both a trimmer and a shunt capacitor to permit a wide choice of shunt capacitance across the crystal. The crystal frequency is always twice the desired suppressed-carrier frequency. If a crystal is being ordered to copy CW or RTTY don't forget to choose your favorite sideband for copying plus a 1-kHz offset or so. Surplus CR-18/U crystals work fine as do

*Crystals are available from Buck-Man Electronics, 120 South Blake, Olathe, Kansas 66061. Specify crystals for the Phase II Receiver. 1 or 2 crystals, \$7.00 each; 3 - 5 crystals, \$6.00 each; 6 - 15 crystals, \$5.00 each; 16 - 25 crystals, \$4.00 each, postpaid.

many of the overtone crystals oscillating on their fundamental frequencies.

power supply

The receiver circuitry may be powered with ac or dc but if raw ac is used the

construction

With some careful shopping it is possible to build the whole *Phase II Receiver* for about \$60. A club or group purchasing at quantity prices can reduce the cost further and put life back into the club

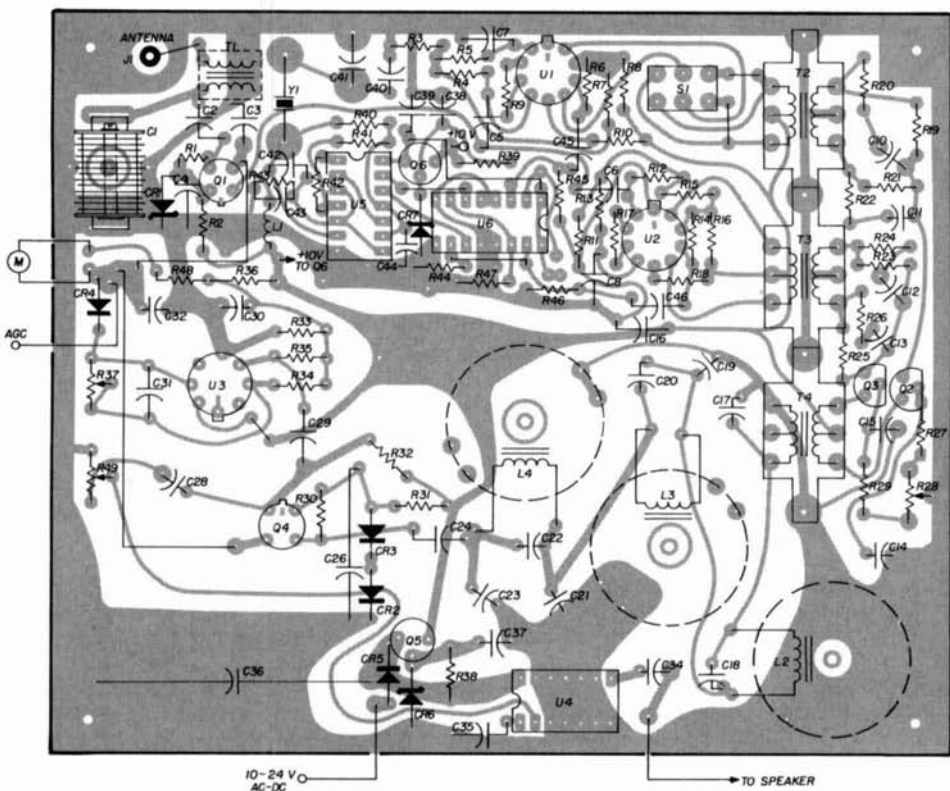

fig. 4. Printed-circuit layout of the complete phasing-type communications receiver.

audio level must be kept low or it will be extremely rough sounding. It is best to full-wave rectify the ac or provide a filter capacitor much larger than the 2000- μ F used on the board. The 10-volt regulator also acts as an active filter to clean up the dc fed to all the low-level circuits. The second regulator provides 6.0 volts for the digital circuitry. Both regulator transistors should have clip-on type heat sinks since they may have to dissipate a couple of watts under extreme conditions.

net, too. Most components are standard stock items and values have been selected to permit quantity purchases. The miniature transformers are not standard but are available below the cost of comparable standard American-made transformers.

The transformers have a red dot on the side with the most turns. The red dot on T2 and T3 is toward the product detectors and the dot on T4 faces R28, the sideband balance pot.

S-meter

Sensitive meter movements are expensive and now even the surplus stock of 100- μ A meters is about gone. A single inexpensive transistor and one resistor will permit use of a readily available 1-mA meter. Most of these meters are not calibrated in S-units or even in dB. The meter in my receiver is very appropriately calibrated in, "wind speed — miles per hour." On 3920 kHz the incoming signals generally run about 80 mph at mid-evening. The transistor and resistor may

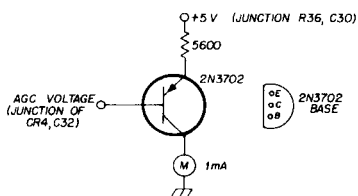

fig. 5. If sensitive 100- μ A meter is not available for the S-meter, this transistor amplifier and 1-mA meter may be used.

be mounted on the board near the agc components or hung on the back of the meter (see fig. 5). Be sure to jumper the old meter pads together to maintain agc action.

Some of the cheap and surplus 741 IC op amps do not have as much output swing as they should and will not pull the agc voltage below 2.0 volts. Even with a good amplifier the voltage will not drop below 1.8 volts. This limits the dynamic range and large signal-handling ability of the receiver. The new Norton or current-mode op amps may be a solution to this problem as well as to the problems of splitting the power supply voltage and floating the amplifier. The LM3900 quad operational amplifier was not available during the development of this receiver but it might be incorporated into a future design with the other three amplifiers used for noise blanking.

alignment

The only adjustments to be made to the completed receiver are to balance the

audio combiner pot for best sideband suppression and to adjust the front-end filter to peak the signal. Of course, the crystal frequency can be trimmed on the nose with the small trimmer capacitor in series with the crystal. Since the product detectors are driven with square waves it might be suspected that there would be strong spurious responses at the odd harmonics.

Data for the MC1496 double-balanced mixer indicates that the second and third harmonic sensitivity should be at least -30 dB even with extremely strong over-driving.¹⁵ The carrier input to the product-detectors causes switching action anyway.¹⁶

troubleshooting

Troubleshooting the receiver is not difficult. The audio output stages can be used to self check the rest of the circuit back to the product detectors. Just remember that the agc voltage is reversed, about 5 volts for a weak signal and nearly 1 volt for strong signals.

A general-coverage receiver will provide a quick check on the crystal oscillator and the digital phase-shifter. You should receive a signal at the crystal frequency and at the desired receiving frequency at one-half the crystal frequency. Integrated circuits U5 and U6 are emitter-coupled logic and are intentionally operated above their normal 5.2-volt supply. The Phase II receiver's low-voltage supply is nominally 6.0 volts which is still safe for the ICs. The oscillator operates more reliably over a wider range and the phase-shifter is slightly more accurate at the higher supply voltage.

operation

Operation of the *Phase II Receiver* at voltages above 20 volts dc is not recommended because of the voltage limitation of the LM380 audio power amplifier IC and the wattage rating of R38. Transistor Q5 gets a little hot under the collar, too. If continued operation at voltages above 20 volts is desired, a 10- or 12-volt, 10-watt zener diode may be added in

series with the power supply line. If only portable battery operation is desired, all the components in the first voltage regulator may be removed since they will only consume power and regulate nothing. However, the input diode, CR5, should be left as a polarity reversal protector.

Unwanted sideband suppression is improved by adding a capacitor from one side of the primary of transformer T2 to the center-tap. This capacitor value varies from 2000 to 10,000 pF with different receivers, but in all cases makes some

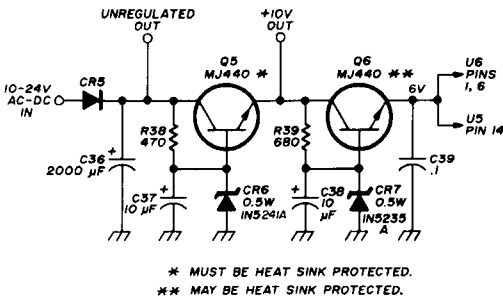

fig. 6. Power supply for the phasing-type receiver operates from 10 to 24 volts, ac or dc.

improvement. Circuit pads have been included on the PC board for this purpose.

Direct-conversion receivers have a peculiar ability that occasionally causes problems. The receiver can receive its own local oscillator. Logically, it would seem that this signal leakage out of the digital phase-shifter would always be within 90 degrees of the received frequency and would be a dc voltage coming from the product detectors. Transformer coupling was used in an attempt to minimize low frequency audio noise caused by self-reception. Certain conditions aggravate the self-reception problem, resulting in an obnoxious buzz. To minimize this problem the following procedures may be helpful. They are listed in order of decreasing importance.

1. Disconnect the frequency counter from the receiver when not taking actual frequency measurements.

2. Ground the receiver to a good ground.
3. Locate the antenna as remotely as possible and use coax feed.
4. Place the receiver board in a well shielded enclosure.

Using a converter with the Phase II receiver seems to present no problems as long as coax is used for signal input.

Strong signal handling, cross-modulation, and overload may be improved by increasing the voltage of zener diode CR1. Although this will result in some loss of sensitivity, on most frequencies below 10 MHz extreme sensitivity isn't all that useful.

No muting feature was provided since it was assumed that the audio output would simply be turned off if a transmitter was in operation. Experimenting with the companion breadboarded phasing transmitter has turned up two more possibilities. Since it is possible to receive your own signal while transmitting it may be desirable to pull the agc line down near ground potential and use the receiver audio as a sidetone signal. The audio can be muted by grounding pin 1 of the power amplifier, U4. A combination of both of these muting methods may be used but the agc line should be left slightly above ground to speed recovery time when switched back to the receive mode.

frequency measurement

Off-the-air frequency measurements are quite easy because there are two unused outputs from the digital rf phase-shifter, either of which may be fed directly to a frequency counter. The exact suppressed-carrier frequency of a sb signal is quickly read.

Reading the frequency of a CW signal or a continuous carrier is much more difficult, believe it or not. Zero beating will not work because there is no output at frequencies near zero beat. The best method I have found for measuring the frequency of CW signals is to compare the 1-kHz output of the counter with a 1-kHz beat note from the receiver on a scope.

This provides exactly 1-kHz offset and can be added to or subtracted from the counter reading, depending upon the sideband used. It is possible to preset some counters to allow for the 1-kHz offset.¹⁴ Crystal drift experienced at 7.6-MHz was only plus or minus 5 Hz over a period of several months.

summary

Four prototypes have been in service for over a year. No two of the prototypes are exactly the same but they all have performed quite well with the exception, perhaps, of the one that chooses its own sideband, but that problem has been cured. Frontend filters have been an absolute necessity to permit operation of adjacent transmitting equipment. Performance is good enough that the Collins 75A-4 has been on the shelf for six months and the R390-A is a standby.

The most obvious follow up project for the receiver is a companion transmitter and a vfo. A breadboard transmitter has been in operation for several months with excellent results, considering the output power of one watt. Signal quality has been the key to success with such low power.

The transmitter is a sort of *reciter* because it does transceive with the receiver and it uses the receiver rf digital phase-shifter. It provides a couple of unique features: it is possible to transmit on one sideband and receive on the opposite — even simultaneously, within the limits of the unwanted sideband suppression. It is also possible to transceive but to monitor your own signal off the air would require a separate receiver and transmitter.

references

1. R. Littlefield, K1BQT, "The Sideband Mini-tuner," *ham radio*, October, 1970, page 16.
2. J. Kaufmann, WA1CQW, D. DeMaw, W1CER, "A High-Performance Solid-State Receiver for the Novice or Beginner," *QST*, October, 1972, page 11.
3. O.G. Villard, Jr., W6QYT, and D.L. Thompson, "A Detector for Single-Sideband Reception," *QST*, June, 1948.

4. D.E. Norgaard, W2KUJ, "Practical Single-Sideband Reception," *QST*, July, 1948.
5. R.S. Taylor, W1DAX, "A Direct-Conversion SSB Receiver," *QST*, September, 1969, page 11.
6. Ed Noll, W3FQJ, "Direct-Conversion Receivers," *ham radio*, November, 1971, page 59.
7. D. DeMaw, W1CER, "Recent Equipment: Heath HW-7," *QST*, January, 1973, page 48.
8. A.I.H. Wade, G3NRW, "Design Criteria for SSB Phase-Shift Networks," *ham radio*, June, 1970, page 34.
9. F.R. Shirley, "Shift Phase Independent of Frequency," *Electronic Design*, September 1, 1970.
10. E. Wetherhold, W3NQN, "An Amateur Application of Modern Filter Design," *QST*, July, 1966, page 14.
11. E. Wetherhold, W3NQN, "Inductances and Q of Modified Surplus Toroidal Inductors," *QST*, September, 1968, page 36.
12. E. Wetherhold, W3NQN, "Modern Filter Design for the Radio Amateur," *QST*, September, 1969, page 42.
13. G.K. Shubert, WA0JYK, "A Digital 90-Degree RF Phase Shifter," *The Electronic Engineer*, August, 1971.
14. J. Hagen, K7URZ, "A Simple Frequency Counter for Receivers," *QST*, December, 1972, page 11.
15. *The Microelectronic Data Book*, Motorola Semiconductor Products, Inc., 2nd edition, 1969.
16. R. Hejhall, K7QWR, "An Integrated-Circuit Balanced Modulator," *ham radio*, September, 1970, page 6.

ham radio



"This is incredible. . . I've contacted a Captain Lightning in his Mars space ship."

NOW.
Top-of-the-Line
Tri-Ex Towers
for HAM operators
at basic prices!

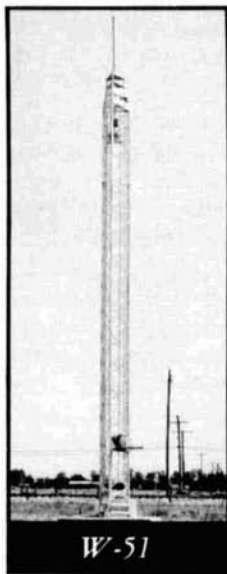

W-51

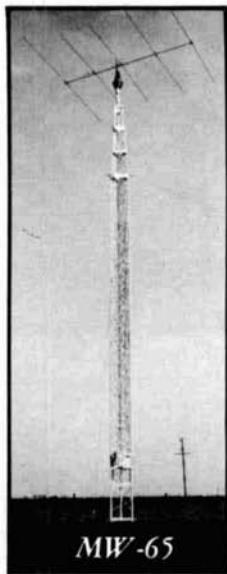

MW-65

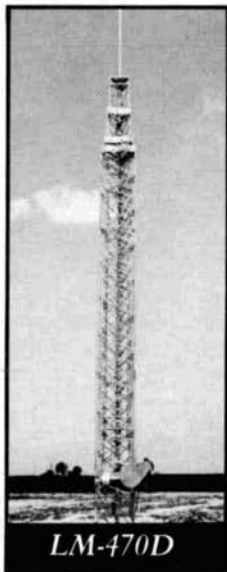

LM-470D

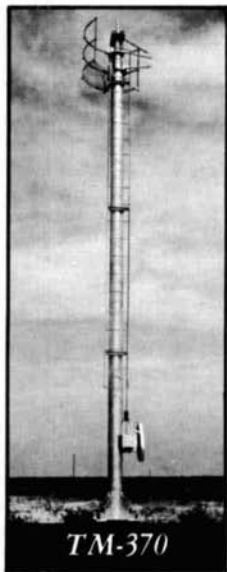

TM-370

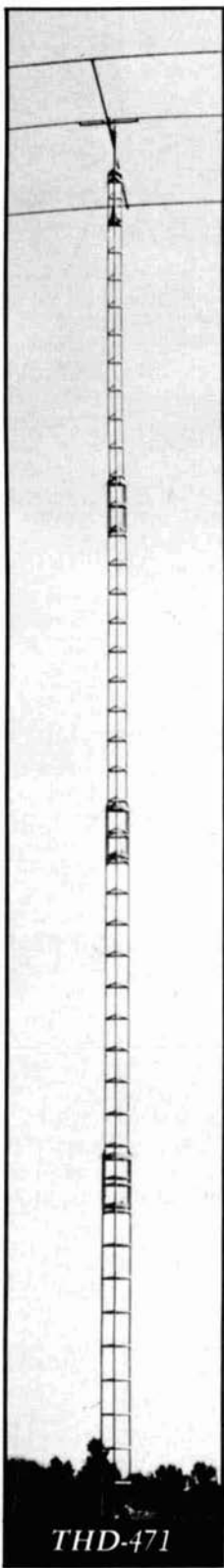

THD-471

Now you can afford the best! Free-standing or guyed, Tri-Ex Towers stress quality. All towers are hot dipped galvanized *after* fabrication for longer life. Each series is specifically engineered to HAM operator requirements.

W Series

An aerodynamic tower designed to hold 9 square feet in a 50 mph wind. Six models at different heights.

MW Series

Self-supporting when attached at first section — will hold normal Tri-Band beam. Six models.

LM Series

A 'W' brace motorized tower. Holds large antenna loads up to 70 feet high. Super buy.

TM Series

Features tubular construction for really big antenna loads. Up to 100 feet. Free-standing, with motors to raise and lower.

THD Series

Very popular. Low Cost. Holds Tri-Band antennas. Eight models — all support 7 square feet of antenna at full height in 70 mph winds. Guyed.

Start with Top-of-the-Line Tri-Ex Towers. At basic prices. Write today, for your best buy.



TOWER CORPORATION

7182 Rasmussen Ave.
 Visalia, Calif. 93277

high-gain log-periodic antenna

for
10, 15 and 20

This 17-element
log-periodic antenna
provides approximately
13-dB gain
over three
amateur bands

In a previous article I described two fixed, doublet-type log-periodic antennas which cover the entire frequency range from 14 to 30 MHz.¹ Although both of these antennas have 12 elements, one, 70-foot long, provides approximately 10-dB gain. The other, 40-foot long, gives approximately 8-dB forward gain.

Since writing that article I have built eight more log-periodic antennas for various frequency ranges, including several for 40 meters.² One of these log periodics which is especially interesting uses 17 elements to provide 12- to 13-dB forward gain on the amateur 20-, 15- and 10-me-

ter bands. This antenna is of interest to amateurs who want a single fixed wire beam aimed in one particular direction and it will be described here.

the antenna

The high-gain, three-band log periodic shown in fig. 1 is 100-foot long and has an apex angle of 16 degrees ($\alpha = 8^\circ$). The minimum space required for this antenna is approximately 125-foot long by 80-foot wide. Four masts or other supports are required. The antenna is suspended between the four masts with two nylon catenary side lines as shown in fig. 2.

Unlike the antenna described in reference 1, the center open-wire feedline carries some of the weight of the antenna. This eliminates two of the nylon support lines used in the earlier design.

I used number-15 aluminum wire for both the center feedline and for the 17 active elements. The use of aluminum wire minimizes overall weight of the large antenna. This wire is manufactured for use in electric fences and is available from Sears (catalog number 13K22065) at \$8.70 for a quarter-mile roll. Approximately 570-feet of wire are used in this three-band log-periodic antenna.

Although this aluminum electric-fence wire is strong and inexpensive, be careful not to put any kinks in it when you are putting the antenna together — aluminum wire breaks easily after it has been once kinked. As with any aluminum wire, special precautions must be taken when making electrical joints and splices.

If you use sturdy steel masts or wooden poles for the four antenna supports, copper wire can be used for the antenna.

George Smith, W4AEO, 1816 Brevard Place, Camden, South Carolina 29020

However, the weight of the antenna will be much greater. At my station I use 75-foot-high pine and cedar trees for supports, so antenna weight must be kept to an absolute minimum.

construction

As with my previous log periodics, the center insulators are made from ¼-inch thick lucite or plexiglass as shown in fig. 3. The center element ends are attached to the two outer holes; the center open-

Ceramic egg insulators can also be used for the end insulators for the front and rear elements, up to 250 watts. For higher power, 6- to 8-inch Isolantite antenna insulators are better. Monofilament fishing line, 40- to 50-pound test, is used as end insulators for the rest of the elements. I used 40-pound test monofilament from Sears (catalog number 6KV32232), priced at \$1.88 for a 325-yard spool.

The center feedline to each of the

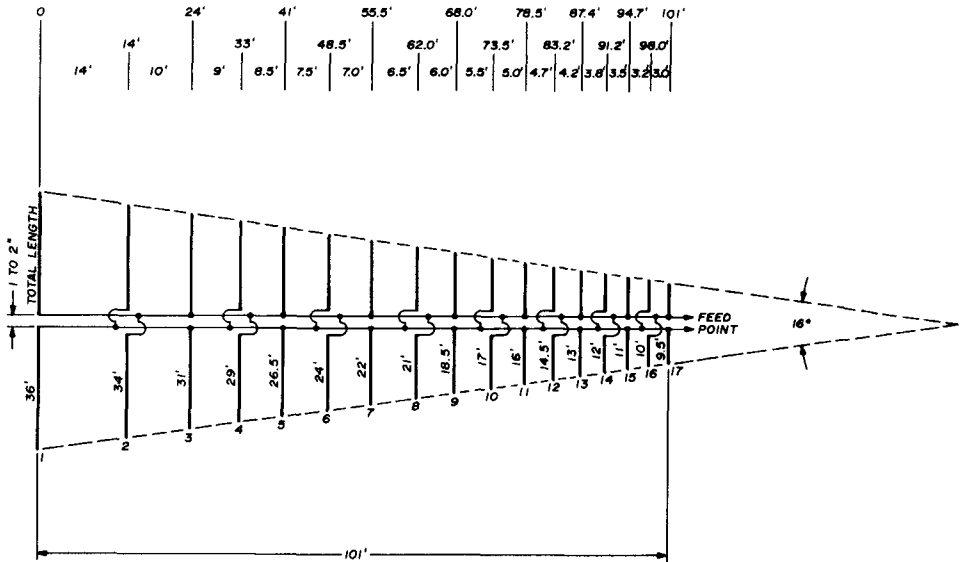

fig. 1. High-performance log-periodic antenna for 20, 15 and 10 meters uses 17 elements to provide approximately 13 dB gain. Installation requires four support masts and a space 125-feet long by 80-feet wide.

wire feedline passes through the other two.

The center insulators are secured to the open-wire feedline by serving several turns of number-18 tinned copper wire over the feeders on each side of the insulator as shown in fig. 4.

The photograph shows a mockup of the center feedline and element arrangement. (In this mockup the elements are much more closely spaced than in the actual antenna.) Ceramic egg insulators are required at the front (element 17) and rear (element 1) because the homemade insulators will not take the stress at these points.

elements must be transposed as shown in fig. 1. The photograph shows that the necessary crossover is located below the center insulator — this provides a rain drip and lowers the center of gravity of the antenna. Since this log periodic uses an odd number of elements, the front and rear element connections do not have to be transposed, and the center feedline can be connected directly to the ends of the front and rear elements. You can use a 4:1 balun and coaxial line or 300-ohm tv twinlead with this antenna, as described in the previous articles.

The photo also illustrates the aluminum-to-aluminum connections between

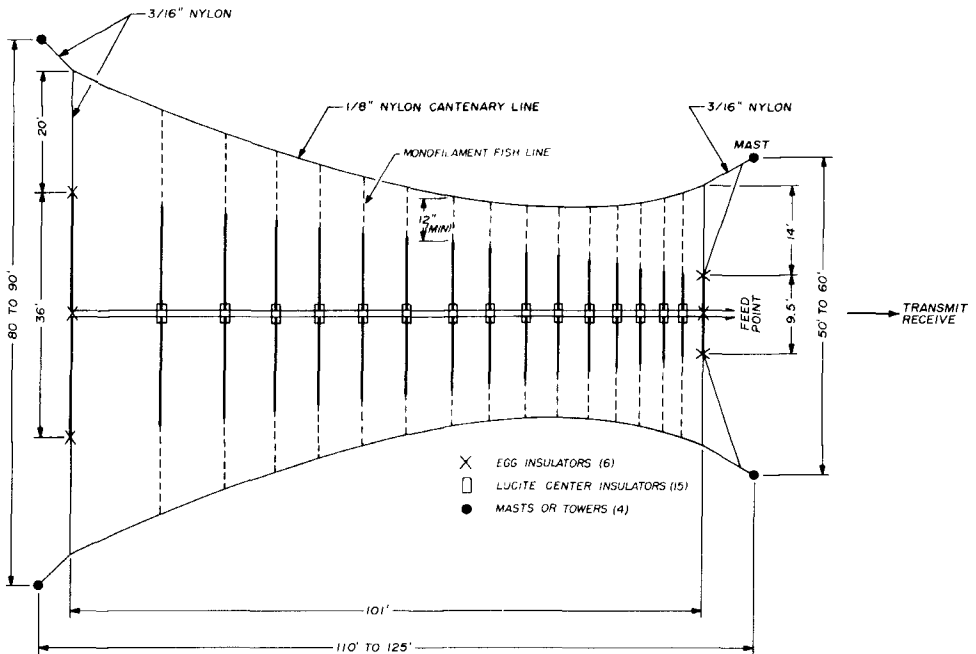

fig. 2. Installation of the 17-element log-periodic antenna. Masts should be a minimum of 40-feet high — 70 feet is better.

the elements and the center feedline. The center element ends are cut 10 to 12 inches longer than the specified element length. This extra length is then fed through the end hole of the center insulator and given three wraps over the element to secure it to the insulator. The remaining length is connected to the center feedline.

All aluminum-to-aluminum electrical connections use mechanical joints. When connecting the transmission line or balun to the antenna, use stainless steel or cadmium-plated hardware. By using large cadmium-plated shakeproof washers with internal teeth good contact can be made to the aluminum wire. I used this method with my first log periodic, and it has been in constant service since September, 1970, with no corrosion or electrolytic problem, to date.

If copper conductors must be used at the feedpoint, use large cadmium-plated terminals or solder lugs, bolting them to the aluminum wire with plated screws and nuts. This eliminates any direct alu-

minum-to-copper contact that could lead to problems with electrolysis.

performance

This is the highest gain log periodic I have built so far. It is beamed west and is installed about 60 feet above the ground. Stations in California often tell me I am the strongest W4 on the band. Considering that I'm using a barefoot transceiver, while most of the competition are running 1000 watts, it gives me satisfaction to know that by properly using a few hundred feet of wire, such gain is possible for less than \$20.00.

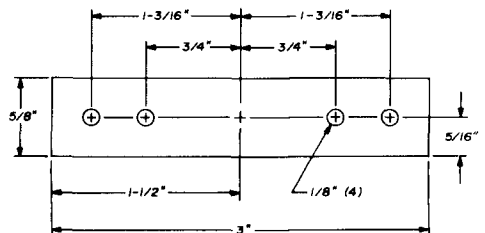
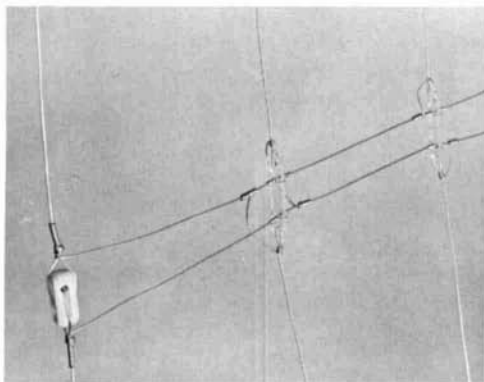

fig. 3. Center insulators for the log-periodic antenna. Material is 1/4" lucite or plexiglass.



Mockup of center feedline showing installation of the center insulators and mechanical aluminum-to-aluminum connections.

I have not tried to make quantitative front-to-back or side attenuation tests, but from on-the-air tests signals from stations off the side of the antenna seem to be about 30-dB down. This is a great help here for attenuating the extremely strong signals that pour in from South and Central America.

I have not been able to obtain much data on the front-to-back ratio as there is not much to the east of here except the Atlantic Ocean. However, I was recently monitoring a VK1 in the evening by long path from the east. He was about S4 on my non-gain, non-directional antennas but was absolutely nil off the rear of the 17-element log periodic. I was also recently monitoring a CR6 in Angola — he was good S5 copy with my non-gain antenna, but was only S1 or less off the back of the log periodic. These simple observations seem to indicate that this log

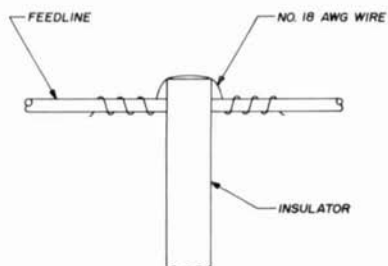

fig. 4. Lucite insulators are secured to the center feedline with a few twists of no. 18 wire.

periodic has a better front-to-back ratio than the other log periodics I have built in the past.

When I designed this long log periodic I tried to improve the front-to-back ratio by increasing the spacing between elements 1 and 2 to 0.2-wavelength. This is 14 feet, as opposed to a spacing of 11 feet which would be normal. Normally the front-to-back ratio of a log periodic is 14 to 15 dB minimum. However, to date I have not been able to determine if the increased spacing between elements 1 and 2 was of any help. The rest of the element spacings are normal for a log periodic having this boom length and apex angle.

summary

If you need a high-gain, fixed beam

table 1. Price list of materials for the 17-element log-periodic antenna.

600-feet	no. 15 aluminum electric-fence wire	\$ 3.60
250-feet	1/8" nylon line	7.50
100-feet	3/16" nylon line	5.00
25 sq. in.	1/4" lucite for center insulators	1.00
6 each	ceramic egg insulators	.90
1 roll	40-pound monofilament fishing line	1.88
		<u>\$19.88</u>

and have the available space, a long log periodic should be considered. Even a long log periodic of this type requires less acreage than a rhombic antenna designed for the same gain on 20 meters. Furthermore, unlike the rhombic, the gain of a log periodic does not fall off at the lower end of the frequency range. If anything, the log periodic seems to perform slightly better at its low frequency end.

references

1. George Smith, W4AEO, "Three-Band Log Periodic for 20, 15 and 10," *ham radio*, September, 1972, page 28.
2. George Smith, W4AEO, "40-Meter Log Periodics," *ham radio*, May, 1973, page 16.

ham radio

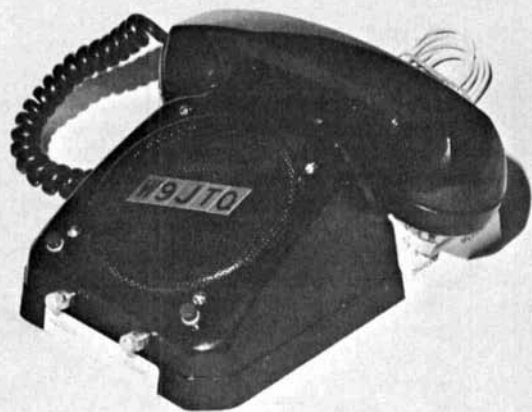

two-meter fm base station

A compact rig
with 12 channels
built into
a telephone
desk set

Al Ericson, W9JTO, South Washtenaw Avenue, Chicago, Illinois

For the amateur who wants his 2-meter fm base station in the living room, this desk set should be the answer. At a glance it appears to be just another telephone. But underneath are 12 channels for transmitting and receiving, each individually selectable. The desk set uses Motorola HT-220 handy-talky circuit boards, which are easily adaptable to a compact rig such as this. In addition to the rf circuits, an ac regulated power supply completes the desk set base station.

If you're close to a repeater or have an efficient antenna, the two watts output from the desk set will be sufficient to capture the repeater with full quieting. More power can be obtained by adding an outboard solid-state amplifier, such as the Dycomm 101-500E, which can be remotely located and fed with coax cable. The speaker in the desk set, with the 1/2-watt audio output from the receiver section, is ample for base-station use.

The photos and schematic, together with the instructions furnished, should provide sufficient guidance for those who would like to duplicate the desk set.

construction

Space is limited inside the telephone desk set, but with care all components can be accommodated. A parts list is provided in **table 1**.

The following additional holes must be drilled in the desk set metal base (see photos for dimensions):

1. Three holes for mounting the HT-220 chassis assembly.
2. Three holes for the dc power-supply circuit board.
3. Two holes for the power-supply transistor heat sink.
4. Four holes for the power-transformer mounting bracket.

4. Four holes for mounting the ac line switch and fuse holder.

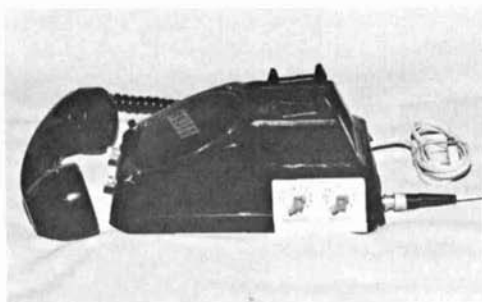

Separate channel selector switches for transmit and receive.

The following parts and subassemblies are mounted on the telephone desk set:

1. HT-220 chassis assembly (refer to photos and description).
2. 110 volt/24 volt ac power transformer with two right-angle metal mounting brackets.
3. Dc power supply circuit board with three 3/8-inch-high mounting posts.
4. Dc power supply regulator transistor, mounted on sheet-metal heat sink.
5. Coax connector, mounted to rear edge of base.
6. Ac line switch, fuse, and line cord.
7. Volume and squelch controls and indicator lights.
8. 40-45 ohm dynamic speaker.

description of subassemblies

The HT-220 circuit board is mounted in a Motorola part No. 7D83124H-1-D metal base, which acts as the heat sink for the final amplifier transistor. This assembly is mounted on 5/16-inch posts at the four corners of the telephone desk-set

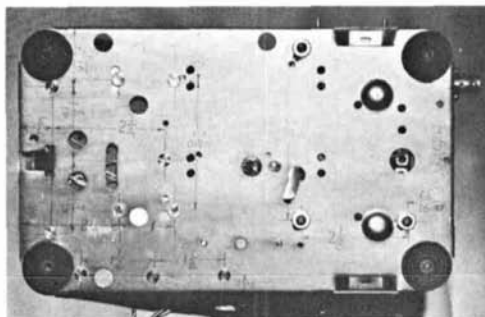

Baseplate hole layout.

5. Two holes and a small cutout in the rear lip of the base for the coax rf output fitting (not visible in the photo of the base).

Drill and file the following holes in the plastic case:

1. Two holes for volume and squelch controls (front edge).
2. Two holes for channel selector switches (right side).
3. One slotted hole on rear edge for the coax connector.

table 1. Complete parts list for the compact two-meter base station.

quantity	item	quantity	item
1	Motorola desk set housing with cradle switch, speaker grill, and handset	1	miniature mike cartridge for Motorola HT-220 with rubber mounting pad (part no. 50-82157JO1)
1	Motorola HT-220 circuit board with control relay for remote operation	2	24-volt Dialite pilot lights
1	Motorola 7D83124HO1-D metal chassis housing with mounting screws for HT-220 circuit board	1	110-volt/24V 1 amp transformer (Olson part no. T-290)
4	3/16 in. diameter x 5/16 in. long spacers to mount housing to telephone base	4	1-amp 200-volt rectifier diodes (Radio Shack part no. 276-1102)
1	Motorola 15E84004/HO1 plastic spacer sleeve with mounting screws for crystal deck circuit board	2	500 μ F, 35-volt electrolytic capacitors (Radio Shack part no. 272-1018)
1	chassis-mount BNC coax connector for antenna output	1	Motorola HEP-247 transistor for regulator
1	25k volume control - use miniature control from HT-220 circuit board - part no. 18-83561HO2	1	Motorola HEP-607 15-volt 1/2-watt zener
2	5k squelch control (Motorola part no. 18C83560HO1)	1	1500-ohm 1/2-watt resistor
2	miniature knobs for above for 1/8 in. diameter shaft	1	3/4-amp AGC fuse (Radio Shack part no. 270-1272)
2	12-position miniature Grayhill switches for channel selectors (part no. 51YY23047-1-12N)	1	3-3/4 in. x 2-5/8 in. perf board (punched) for power supply (Olson part no. K-116)
2	bar knobs for above (for 1/8-in. shaft)	1	spst toggle switch (Olson part no. SW-384)
1	4-inch dynamic speaker with 40-50 ohm voice coil	1	panel-mounted fuse holder (Radio Shack part no. 270-364)
		1	6-terminal barrier strip (Radio Shack part no. 274-650)
		1	special Motorola fuse (do not substitute) (Motorola part no. 65B82896B03)

Note: The Motorola HT-220 circuit boards, desk set, and Motorola parts are available from Spectronics, Inc., 1009 Garfield Street, Oak Park, Illinois 60304. When you order your HT-220 circuit board, request the schematics. Cost is 10 cents per 8-1/2 x 11 page, or about \$1.00 a set.

base. The two Grayhill part no. 51YY23047-1-12N 12-position channel switches are mounted on the 1/8-inch-thick battery end of Motorola part no. 15E84004HO1 plastic extension (see table 1) for the thick-pack HT-220, from which the battery section is sawed off and discarded. The hollow tubular member that houses the collapsible antenna must also be sawed out of the inner part of the plastic extension sleeve to provide space for the transmit and receive crystals, their coils, and the channel switches. Note that this sleeve is turned 180 degrees from the way it is normally mounted in a handy-talky.

A special circuit board was prepared for the 20 channels on the board which,

including the four channels on the HT-220 board, gives 12 transmit and 12 receive channels. This board has holes above each tuning slug in the HT-220

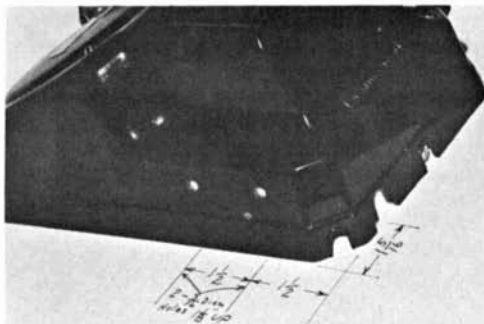

Hole dimensions for channel selector switches and antenna coax connector.

chassis, so that the rig can be tuned without disassembling the crystal deck from the HT-220 deck. One crystal coil slug is inaccessible from the top, but a hole already exists in the bottom of the desk-set base through which it can be adjusted.

A terminal strip is fastened to the side of the HT-220 chassis and is used to connect the telephone handset terminals to the circuits. Squelch and volume controls are located on the front skirt of the handset, so leads must be extended from the HT-220 chassis assembly to these controls, the dc power supply, and the handset cradle switch. See photos for details and refer to the schematic (fig. 1).

HT-220 board preparation

The HT-220 circuit board, as received, contains a relay for remote control of a speaker and microphone. Unsolder and remove the following:

1. Green lead from pin 10 on IC 101 on the back side of the board.
2. Blue/green lead.
3. White/brown lead.
4. Brown/green lead.
5. 80-ohm resistor and green/white lead.
6. Ground lead (black) at edge of board by relay.

Do not remove the following:

1. Grey, yellow, violet leads (squelch control).
2. White/orange, white/yellow, white/blue leads (receive crystal switch).
3. White/red, white/green, white/brown leads (transmit crystal switch).
4. Black, brown, green leads (volume control).
5. Black/red (relay-control lead).

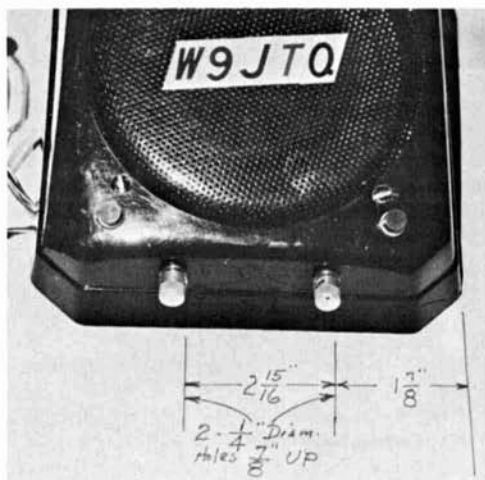

Mounting dimensions for volume and squelch controls.

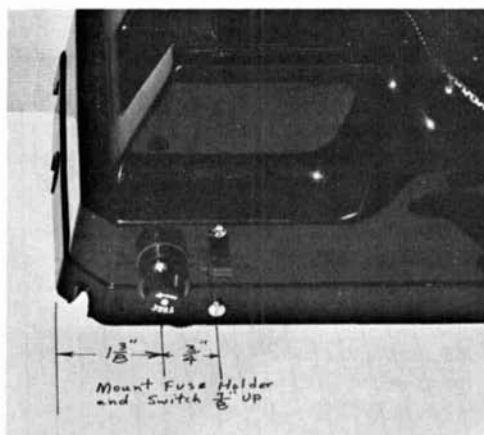

Mounting dimensions for ac power line fuse and switch.

lead dress. All the above leads will either be extended or replaced. Use Teflon-covered wire for extensions if possible. Unless you're experienced in working on printed-circuit boards, it is recommended that you extend the wires rather than try to run new leads from the board. Make a chart showing the relationship between original wire colors (on the board) and those you use to make the extension. Use a 3/8-inch-long piece of 3/64-inch-diameter heat-shrinkable tubing over each splice. Now continue as follows:

1. Clip black, green and brown leads 1/2 inch from volume control and extend each lead 9 inches. These leads will be

later connected to a volume control on the speaker.

2. Unsolder the red leads from the on-off switch on the volume control. Unsolder and remove the red lead connected to the pin jack on the board. (This pin jack *will not* be used for the + battery connection.) Join and extend the two red leads removed from the switch to about 3

3. Install the crystals as follows: Y-1 (transmit) and Y-101 (receive) nearest the end of the board; Y-201 (transmit) and Y-301 (receive) next to Y-1 and Y-101.

4. Extend the brown, yellow and purple leads 7 inches. These leads will be connected later to the squelch control.

5. Extend the following leads 4 inches: black/red control lead from the relay and the black (ground) lead from board next to the relay.

Note that the transmit section runs vertically along one side of the board and is easily identified by the final amplifier power transistor. The receive section runs along the opposite side of the board.

crystal-deck circuit board

The crystal deck was designed with the following objectives in mind:

1. To be able to peak up the HT-220 circuits with the crystal deck in place.
2. Isolation of crystals and peaking coils from the transmitter rf power output transistor.

These were met by using the layout shown in the photo showing the finished crystal deck wired to the selector switches. Receive crystals are located in the two left-hand vertical crystal holders and in the two left-hand positions of the upper horizontal molded rubber crystal holders. The transmit crystals are located on the right-hand side of the board. Note that the lower right-hand corner of the board is not used (it is directly over the transmitter power output transistor).

assembly. The circuit board is a 2-1/4x3-1/2-inch piece of fiberglass reinforced epoxy circuit board stock. A parts list is presented in **table 2**. The trimmer coils for each crystal are press-fitted into the holes in the circuit board. Note that holes have been drilled into the crystal deck board directly above the coils on the HT-220 circuit board so that the entire coil set can be peaked without disassembling the crystal deck. Press-fit term-

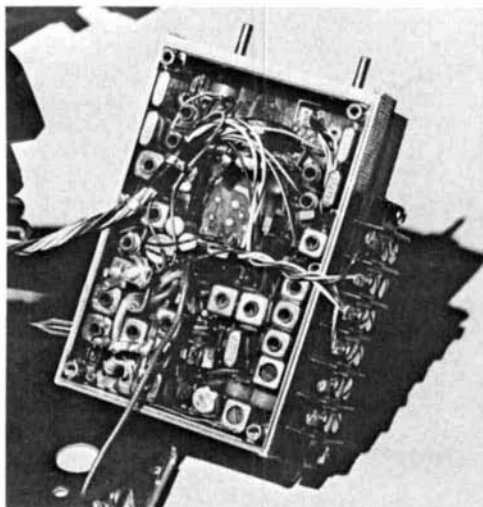

HT-220 chassis assembly (top view).

inches. (One red lead goes to the relay; the other goes through an rf choke to the circuit board.)

channel selector. The channel-selector switches are separate 12-position Grayhill switches which are used for selecting the transmit and receive channels. The two transmit and two receive channels on the 220 circuit board are connected to positions one and two as shown in the schematic diagram in **fig. 1**. It is not necessary to strap the selector switches as is required when one switch controls both transmit and receive channels. This is because you can select any channel to transmit and/or receive, independent of one another. When you have completed wiring the selector switches make a chart showing the crystal frequency of each transmit and receive channel position.

inal lugs are located along the edges of molded rubber crystal holder. Short lengths of no. 18 solid copper wire are used as terminal lugs for the connections between the end of the trimmer coil and the lead wires to the band switches. Using pliers, pinch the soft copper wire on each

It is recommended that the wiring on the circuit board be completed before connecting the leads to the two selector switches.

The layout shown worked out well and met the objectives. If you eliminate the need to tune up the HT-220 circuit

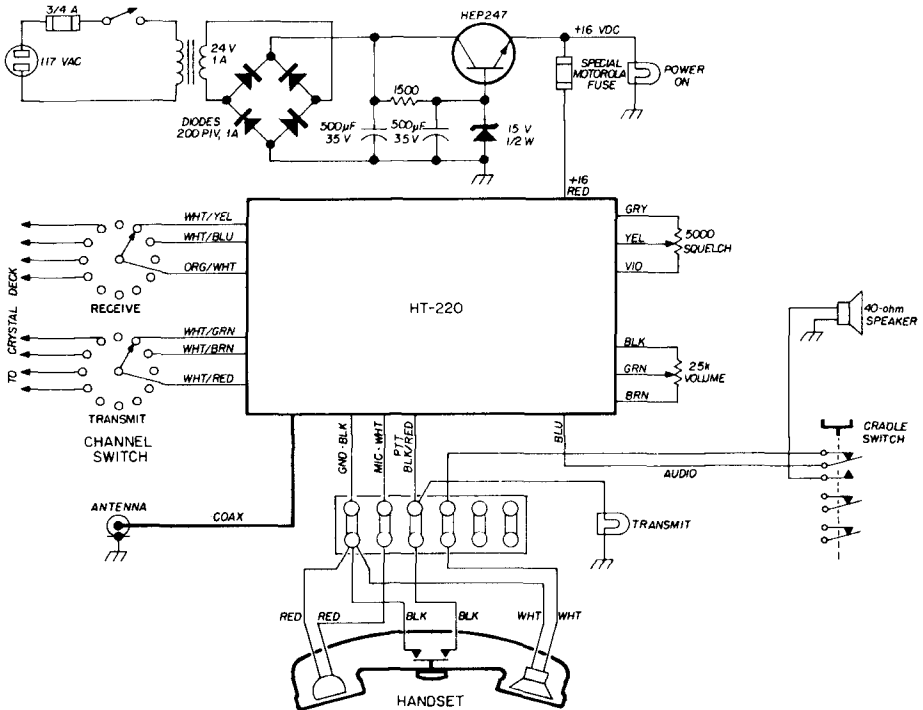

fig. 1. Power supply and interconnecting circuits for the HT-220 desk set base station.

side of the circuit board to lock it in place. Number 16 solid-copper wire is also used as the ground strap between the molded rubber crystal holders.

The 1/8-watt resistors in parallel with each crystal are mounted over the top of the molded rubber crystal holders between crystals. They will just fit. Don't try to use a resistor larger than 1/8 watt. The terminal at the very top of the circuit board between the two selector switches is connected to the discriminator circuit to accommodate a high-impedance meter, which can be used to zero in each receive crystal on the channel.

board without removing the crystal deck, considerably more leeway can be used in the layout.

One word of caution: with transmit and receive channels on separate switches, you must double check each time you change channels to be sure you have both the transmitter and receiver on the proper channels for the repeater you are working.

power supply

Fifteen volts at 500 mA are supplied by the power supply. Note that the transformer recommended (table 1) must

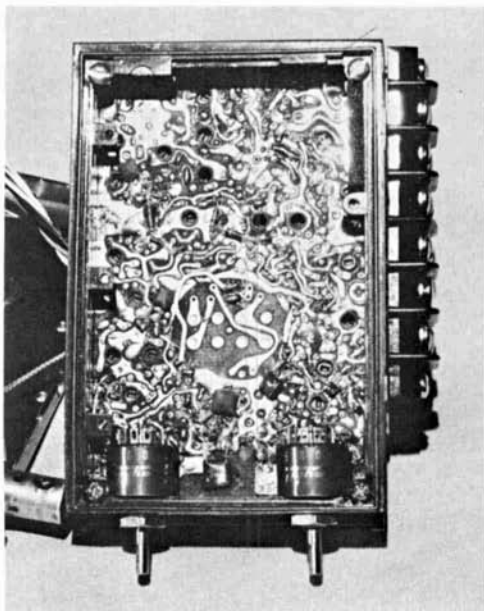

HT-220 circuit board (bottom view).

fit under the handset cradle switch. If you substitute another type of transformer, make sure it will fit into this space. All other components, except the voltage regulator transistor, are mounted on a perf board located under the speaker (see photos for details). A 15-volt zener controls the regulator transistor, which is mounted on a metal heat sink at the left-hand side. The regulated power transistor is insulated from the heat sink with a thin mica sheet. Use a transistor mounting kit and template to prepare the heat sink and to mount and insulate the transistor. Silicone grease should be used between the transistor and metal heat sink.

Note the use of component lead wires through the holes in the perf board for mounting and wiring the components. Mount the ac line switch and fuse holder. Ribs inside the plastic case must be cut off with a sharp wood chisel to accommodate the line switch and fuse holder. Next, connect the line cord. The lug on the end of the fuse holder may have to be partially cut off and insulated with tape to clear the HT-220 chassis.

Leave a service loop so the top plastic cover of the desk set can be removed

while working on the set. Also, note that all leads except the antenna coax are in one cable so that the chassis can be easily removed for servicing.

miscellaneous mods

microphone. The handset carbon mike is removed and a Motorola miniature magnetic cartridge unit (table 1), made for the HT-220, is substituted. See photo for mounting details.

speaker. The handset is wired so that the speaker is enabled when the handset is in its cradle, and audio is switched to the earpiece when the handset is lifted from the cradle. The 40-45 ohm, four-inch-diameter speaker must be thin enough so it won't interfere with the cradle-switch level arm. Although the 4-ohm speaker supplied with the handset has a special cutout in the metal support arms, this speaker can't be used in this application because its voice coil impedance is too low for the HT-220 set, and its magnet is physically too large and will interfere with the power supply circuit board.

top cover assembly. To assemble the top cover on the desk set, remove the screw on the HT-220 chassis at the end nearest the right-hand side of the base, and

table 2. Crystal deck parts list.

quantity	item
1	3 x 4-inch fiberglass reinforced epoxy circuit board (Circuit-Stik Quik Circuits part no. 9354 or equivalent)
10	Motorola 24-83638H14 coils - (transmit)
10	Motorola 24-83638H13 coils - (receive)
5	Motorola 7-84274H01 molded rubber crystal holders
10	Motorola 6S185B78 1/8-watt 820-ohm resistors (receive)
10	Motorola 6S185B75 1/8-watt 470-ohm resistors (transmit)
21	press-fit PC board solder terminals
2	flat head Phillips screws
1 ft.	no. 16 bare copper wire for ground straps and coil terminals
20 pcs.	no. 26 gauge Teflon insulated hook up wire, 5-inches long

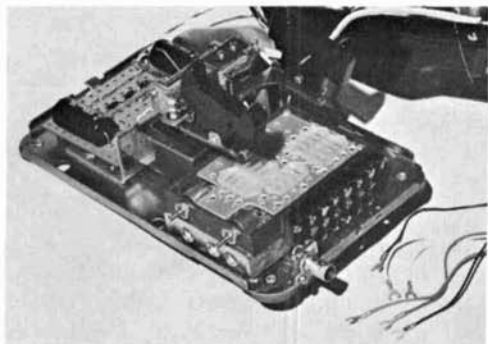

Crystal deck circuit board, BNC coax antenna connector, and terminal strip for handset.

loosen the rear screws so that the HT-220 chassis can be tilted upward to get the channel switch shafts through the holes in the right-hand side of the plastic telephone-set housing. The cradle levers must be manipulated through their slots, and the front hook on the bottom base must engage the slot at the front of the cover. It may be necessary to wedge the hook in place with a screwdriver.

Check the cradle switch to ensure it works freely after the screw at the rear of the desk set housing has been tightened. Note that the on-off switch bottom mounting lug should be on the inside of the lip on the base. Loosen this screw while assembling the set and retighten. Install the channel switch knobs.

rf section. Small padding capacitors are sometimes needed in the driver and final-amplifier circuits. Add these capacitors, one at a time, as you go through the tune-up procedure and determine if they

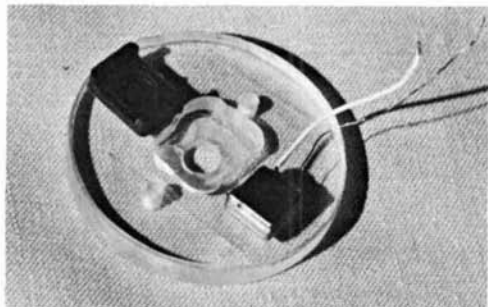

HT-220 miniature mike cartridge, molded rubber holder, and plastic adapter plate.

help to increase power output. Monitor the dc input to the HT-220 board during tune up, and do *not* keep the power on for more than a few seconds if the current exceeds 425 mA, since there is danger of damaging the driver transistor. Adjust final-amplifier tuning to reduce current to 400-425 mA.

When feeding a remote power amplifier, limit the length of small coax cable used at the output of the desk set to five feet or less. If you must run a longer cable to the remote power amplifier, use larger cable; preferably RG-8A/U. The short length of small-diameter cable at the desk set is only meant to give flexibility in moving the radio around on the desk.

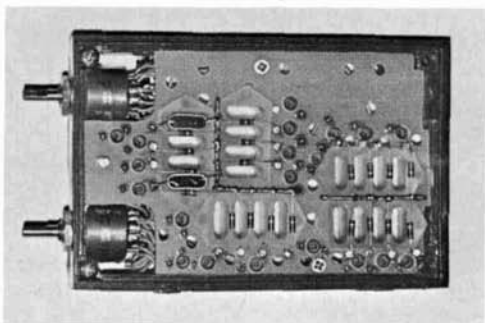

Assembled crystal circuit board connected to selector switches.

final remarks

Schematics and tune-up instructions should be obtained when you buy your board (available at nominal cost). The matching filter between the coax feed line and antenna is not necessary; the match is satisfactory without it.

Name plates for the channel switches, volume control, and squelch control help dress up the desk set. Your call letters could be substituted for the Motorola name escutcheon on the speaker grill.

This is a very nice rig. While it's a narrowband set (5 kHz), it accepts 8 - 10 kHz deviation without much distortion and sounds fine on most repeater operations.

ham radio

television DX

Chasing broadcast
television DX
is a step above
short-wave listening,
and provides
some interesting data
on vhf
propagation modes

There is a usual pattern leading up to the time when a person becomes a ham. Many of us started out by listening to a distant station on an a-m broadcast radio, only to graduate up to shortwave listening. And finally, often with the aid of an amateur acquaintance, we worked for, and earned, an amateur radio license.

My own interests followed a somewhat different route. I, too, went through the listening stage, but I was rather intrigued with *seeing* DX as well as hearing it. What I am referring to of course is *TV-DX* — receiving normal television stations, during abnormal conditions, over relatively great distances.

Television DX is made possible by the same propagation vehicles as DX on the

vhf and uhf amateur bands. Band openings are just as exciting, and with the added dimension of video, far more dramatic. Somehow, *watching* 1000-mile distant stations float in with sparkling clarity or even heavy snow has an attraction all its own. Suddenly, you're *seeing* heterodynes, meteor bursts and auroral flutter. Whether the signals are originating from a five-megawatt station or a low power relay, the excitement is still there.

As you will see, television DXing can also be of practical advantage to the amateur. Whether it is used as a research tool or simply as an early warning device for vhf and uhf openings, television DX should be more than a novelty to the serious vhf enthusiast. This aspect of TV DX will be covered later in this article.

propagation

Without exception, the same types of propagation that affect the vhf ham bands affect the TV broadcast channels. Since much has already been written in handbooks and magazines about vhf and uhf propagation, and because of space limitations, I have chosen to include only brief details here. Several references to more detailed studies of vhf propagation are included at the end of this article. It is, however, worth pointing out that you should avoid older texts on the subject. Much of what we know about vhf and uhf propagation has only been detailed in the past 15 years or so. Most earlier texts are full of false assumptions. The articles cited will provide the most up-to-date information.

Tropospheric bending Tropo, which is sometimes known as extended ground wave, is a weather related phenomenon affecting both the vhf and uhf television

Morrie S. Goldman, WA9RAQ, 5815 North Christiana Avenue, Chicago, Illinois 60659

channels. Several variations of this propagation mode exist, all requiring the influence of a high-pressure area. Basically, when a temperature inversion takes place in the troposphere, a strata develops which forces vhf (and higher) signals to follow the curvature of the earth. This continues for the length of stratified layer, anywhere from 60 to 1000 miles.

Sometimes two layers form close enough to each other to simulate a wave guide, *ducting* signals for 350 to 1000 or more miles. *Tropospheric ducts* often channel signals over all points between the transmitter and receiver, much like skip. Since the duct is a waveguide, it may affect a relatively small frequency range (such as part of the uhf band), or it may be large enough to affect the entire TV spectrum. Ducts are most common along the edge of a weather front.

The warmer months and especially the autumn are best for tropo, although it can occur during any season. Best times are usually around sunrise and sunset when rapid heating and cooling in the troposphere takes place. Tropo is characterized by steady signals and slow fading.

Sporadic-E skip (Es) Also known as short skip in amateur circles, Es is most common in the late spring and early summer months, with a secondary lesser peak occurring from mid-December to early January. Best times are most often from mid morning to early afternoon and from early evening to about 2230, local time. Sporadic-E occurs when vhf signals hit sporadic patches or *clouds* of ionization in the E layer of the ionosphere and are refracted to a distant point. Typical distances for a single hop range from approximately 450 to 1400 miles.

Double and even triple hops are possible and have been reported, but are not very common. Es begins low in frequency and as the density of the patch increases, so does the muf. Es commonly affects all of the low band (channels 2-6) and occasionally extends to channels 7 and 8 in the high band. Es is the most unpredictable and misunderstood of all the types of ionospheric propagation.

Sporadic-E propagation is characterized by strong signals and deep fading. Reception can last for minutes, hours and in some rare cases, days.

F2 layer skip (F2) During years of peak sunspot activity the F2 layer of the ionosphere can provide a daily reflective barrier to vhf signals. Skip distances begin at about 1700 miles. With multiple hops, the ultimate range is unlimited. During the past sunspot peak, the muf seldom reached our channel 2, but did bring in 41-MHz TV audio signals from France and England. In 1957, George Palmer of Williamstown, Victoria, Australia, set the world's TV-DX record by receiving BBC-TV audio by long path F2 over a distance of 14,500 miles. The video was received on another occasion during the same year by short path F2 over a distance of 10,400 miles!

Auroral Scatter (As) The *aurora borealis* or northern lights does more than wipe out low-frequency DX — it causes DX to occur at vhf. Though once thought to be relatively well understood, auroral scatter is of increasing interest to researchers. It can propagate signals anywhere from several hundred to several thousand miles. Aurorally propagated signals are characterized by rapid flutter. In fact, this flutter is usually so intense that it garbles television and audio signals beyond recognition. Only during a small percentage of the magnetic disturbances are signals stable enough to be useful.

Peak signals for auroral scatter DX appear most often toward magnetic north. Reception and visual auroral sightings are far more common in the northern states and Canada than in southern regions.

Auroral peaks seem very closely tied to sunspot peaks. According to ionospheric physicist Gordon P. Nelson, "magnetic and solar activity may lead or lag each other in alternating cycles."* The

**Auroral Disturbances*: A talk presented by Gordon P. Nelson at the 1972 convention of the Association of North American Radio Clubs in Boston, Massachusetts on July 15, 1972.

magnetic peak lagged the solar peak in cycle 20, so we would expect the reverse to be true in cycle 21.

Meteor scatter (MS) When a meteor is pulled toward the earth and begins to burn from friction, it leaves an ionized trail behind. This short-lived ionization

meteor scatter is from about 0400 to 0800 local time when many TV stations are displaying test patterns and ID slides. From midnight until noon, local time, we are at "the front of the earth," catching the greatest number of meteors with the greatest force. There are some daylight

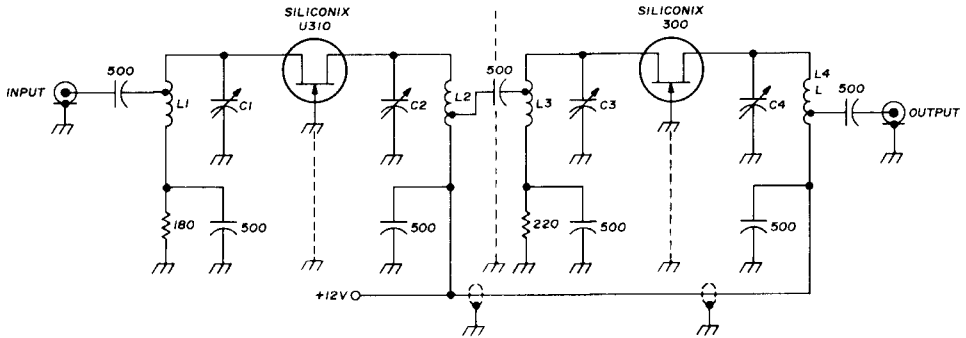

low-band

- C1,C2 3-32 pF variable (E.R. Johnson)
- C3,C4 167-130-1)
- L1 5 turns no. 16, 3/4" diameter, tap down from hot end for best performance
- L2 6 turns no. 16, 3/4" diameter, tapped 3/8-turn from cold end
- L3 5 turns no. 16, 3/4" diameter, center tapped
- L4 6 turns no. 16, 3/4" diameter, tapped 1/8-turn from cold end

high-band

- C1,C2 1.5-5 pF (E.F. Johnson 167-102-1)
- C3,C4
- L1 3 turns no. 16, 3/4" diameter, tap down from hot end for best performance
- L2 3 turns no. 16, 3/4" diameter, tapped 3/8-turn from cold end
- L3 3 turns no. 16, 3/4" diameter, center tapped
- L4 3 turns no. 16, 3/4" diameter, tapped 1/8 turn from cold end

fig. 1. A tunable fet preamplifier for use on vhf TV. For higher performance on the high band (channels 7 through 13), additional stages identical to the second stage may be added.

occurs in the E layer of the ionosphere and creates momentary bursts of E skip. Meteor scatter bursts can last anywhere from a fraction of a second to over a minute and produce DX from about 1100 miles to as close as 180 miles. Most common are signals in the 500- to 900-mile range.

Best results can be expected during meteor showers, when large swarms of meteors enter the earth's atmosphere. (A list of showers can be found in *The Radio Amateur's VHF Manual*, published by the ARRL.) However, there are always sporadic meteors being pulled into the earth's atmosphere.

For TV-DX purposes, the best time for

showers, but on an average, the greatest activity is between midnight and noon.

With average equipment, a great deal of meteor scatter can be observed on the low band TV channels. For results at channel 7 or higher, stacked, cut-to-channel antennas and a low-noise preamp are required.

Lightning scatter (Ls) Lightning scatter is a very interesting and recently discovered mode of propagation. In fact, the discovery is so recent that almost no research has been conducted into its mechanics. This much is known — when very intense thunderstorms are between two points, perhaps from 200 to 500 miles

apart, they can reflect uhf signals between those points. Exactly how the signal is propagated, or why lower frequencies are not affected, has not yet been determined. It is believed that the first recorded observation of lightning scatter was made in June, 1968, by a TV-DXer. In September of that same year W5RCI and WØDRL made the first 432-MHz contact via lightning-scatter propagation.*

Reception during lightning-scatter propagation appears very much like that of meteor scatter. Signals pop in and out with varying strengths. I have even seen signals reach near snow-free levels for several seconds. If any readers have further data on lightning-scatter reception, I would very much like to hear from them.

equipment

Just as in amateur radio, how serious you are about the hobby will determine what caliber of equipment you use. At the bottom of the scale are the occasional TV-DXers, many of whom only choose to use indoor rabbit ears! This is fine for a touch of strong summer sporadic-E, but not much more.

On the average, most TV-DXers are using a quality consumer TV set and a broadband Yagi or log-periodic vee antenna. The antennas are usually fringe-area models.

For uhf reception a separate antenna, of any of a number of types, is mounted on the same mast. The array is rotatable and usually mounted anywhere from 30- to 50-feet above ground. Where overloading is not a consideration, mast-mounted vhf and uhf preamps may be used.

The more serious TV-DXer uses a separate Yagi or log-periodic Yagi¹ for the low and high bands. He often uses stacked antennas for increased gain, capture area and directivity. Single-channel

*The first recorded observation of lightning scatter propagation was described in the August, 1968, issue of the *VHF-UHF Digest*. The two-way 432-MHz lightning-scatter contact is discussed in "The World Above 50 MHz," *QST*, November, 1968, page 89.

antennas are also used for maximum results on a given channel. At vhf, low-loss RG-59/U cable (such as Belden Duo-Foil or International Interfoil 750) is used throughout. For the serious DXer, consumer-type preamps are now taboo because of their susceptibility to overload, the resulting cross-modulation, and

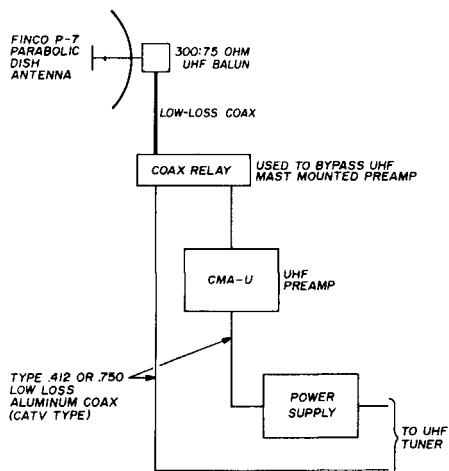

fig. 2. A typical high performance installation for DX reception of uhf TV stations.

poor noise figures. For the vhf TV channels the serious DXer uses a home built tunable, multi-stage fet preamp similar to the one shown in fig. 1. This preamplifier improves adjacent channel rejection and limits video bandpass as well as providing improved noise figure and high gain. Even though there are many tuning knobs, once the dials are calibrated, tuneup is quite fast.

On the uhf TV channels (470 to 890 MHz) a seven-foot parabolic dish antenna is a must. In the reasonable price range the Finco P-7 is about the best available. Once again, consumer type preamps are not used. Their noise figure is often no better than the uhf tuner or converter.

However, there are several CATV-type, broadband uhf preamps that *will* help. Here, the best buy is the Blonder-Tongue CMA-U. Unfortunately, in strong signal areas, overload and cross-modulation can

occur on these units as well. To combat this, I installed a remote 75-ohm coaxial relay, such as the Dow Key 77-2632, to switch the preamp in and out, as needed (see fig. 2).

The uhf antenna and, hopefully, the high-band antennas are mounted a minimum of 50-feet above ground. A minimum of 25-feet should do for the low band antenna. To combat other assorted local problems, the serious TV-DXer uses bandpass filters, tunable traps, attenuators, combine interdigital preamplifiers² and other devices.

The receiver is still generally a high

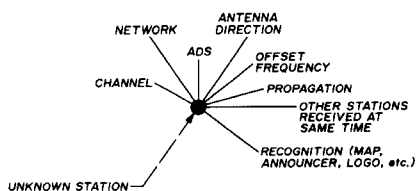

fig. 3. The identity of an unknown TV station can often be determined if there are enough pieces of information (see text).

quality consumer type, but a number of TV-DXers (myself included) have gone to more elaborate CATV-type receivers. These sets boast such features as manual rf gain controls, variable agc positions, video level controls, four i-f stages and other refinements. They do however, require the addition of a video monitor for visual display and an audio amplifier for sufficient audio to drive a speaker.

identifying unknown signals

Often, the TV-DXer finds it necessary to play Sherlock Holmes in an attempt to identify an unidentified signal. Searching for clues, he tries to fit the pieces of the puzzle together. Fig. 3 illustrates some of the required considerations. If enough clues point to one station being the prime suspect, the TV-DXer makes his decision. However, as any good detective or DXer knows, you must not jump to conclusions with insufficient evidence!

One consideration is called *offset*. This refers to whether a station is assigned to

be exactly on channel or is offset, 10-kHz high or 10-kHz low of center. The FCC assigns offset frequencies to minimize co-channel interference. As a side benefit of this, the offset patterns produced when two stations beat against each other can reveal valuable information about one of the stations.

For example, if you are receiving a known station (call it A) on channel 12 and see another station (X) beating against it, you can determine the offset frequency of station X by the offset pattern observed. From a station list, you can determine that station A is assigned to operate on -12.* If the heterodyne of co-channel station X is producing many fine horizontal lines, station X is 20 kHz away (+12). About 10 or 15 larger bars indicates a 10-kHz separation (12 exactly); 5 or 6 still thicker bars indicates zero offset (-12). Thus, if the reference station (A) has a plus or minus offset, you could see any of three possible patterns from an interfering station. However, if station A is exactly on channel, you would see only two patterns (zero and 10 kHz).

Offset lists are not 100% accurate partially because of allocation changes, typographical errors and carrier drift (beyond FCC allowances). Most of the time however, offsets can greatly help in adding another piece to the puzzle.

Time zones are not listed in fig. 3 because many stations delay their broadcasts. This could give you a false impression that a station is farther, or closer (depending on whether you're located in the East or West) than it actually is.

The *VHF-UHF Digest*, described later, features a column devoted to helping TV-DXers decide just what they received.

**Broadcasting Yearbook*, available from *Broadcasting Magazine*, 1735 De Sales Street, NW, Washington, DC 20036, lists all U.S. Television, fm and a-m stations (including tv offset frequency information). The *WTFDA TV Station Guide*, priced under \$5.00, available from WTFDA, Box 163H, Deerfield, Illinois 60015, provides complete listing of U.S. tv stations by channel.

The DXer sends a detailed report of his reception to the column editor, who in turn scans *TV Guides* from around the country. If the editor comes up with a blank too, the report is printed in the hopes that another DXer will recognize the logging and its origin.

confirmations

Amateurs and radio broadcast stations are not alone in receiving QSL requests. Many TV-DXers send their reception data to TV stations and request a written verification. Most stations do verify, and now many TV stations even have their

DX stations as instant proof of reception. The photos are also great for making believers out of skeptics.

It's a simple matter to photograph TV-DX once you know the basics. If your camera has a leaf-type shutter, a setting of 1/30 second at around f/5.6, using Kodak Tri-X film, usually works out well. For cameras using a focal-plane shutter, try 1/8 second at f/8.

Sight and focus the camera so that the entire screen is clearly in view. *Never* use flash, the light bounces off the face of the picture tube, giving you an obliterated photo. For the same reason, reduce the amount of external light striking the screen as much as possible. To prevent camera motion, the use of a tripod is highly recommended.

A highly detailed 8-page booklet entitled, "Photographing Television Images," is available free of charge from the Eastman Kodak Company (Consumer Markets Division, Rochester, New York 14650). Just request Kodak Customer Service Pamphlet AC-10. This booklet describes photographing black-and-white and color TV images using a variety of cameras including movie cameras.

One trick you won't find listed in the Kodak pamphlet is how to turn snowy pictures into clear ones. By using a time exposure of 1/2 to several seconds, you can clear the snow out of a weak picture. Remember to adjust your exposures accordingly. If you have a lightmeter it can be used effectively for TV images as well. As with all forms of photography, practice will improve your results.

vhf amateur applications

Unless you're already too intrigued with TV-DXing itself, you've probably started to think about its amateur applications. The most obvious of these is as a propagation monitor. You may notice the effects of a vhf opening on your TV set before you even turn on your vhf rig. And secondly, once operating, TV-DX observations can aid in determining the geographic coverage of an opening. When used in conjunction with an fm broadcast

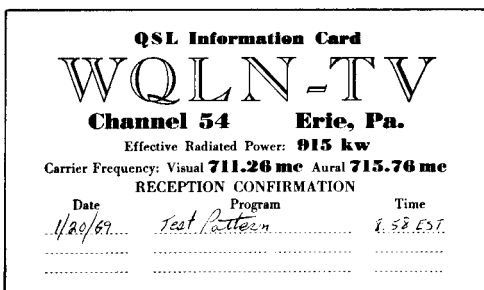
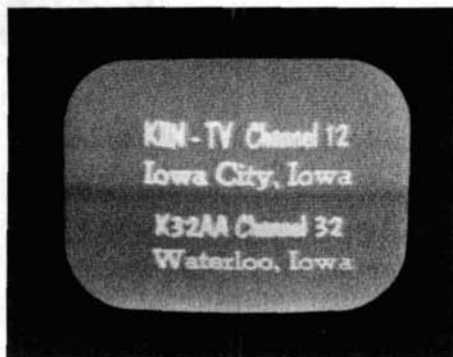

fig. 4. QSL card is typical of many used by other TV stations. This card is signed on the reverse side by Assistant Chief Engineer, WA3DLS.

own printed QSL cards. The chief engineer is usually the "verie signer" and he's often a fellow ham. Most veries (verifications) are still typewritten letters and often carry some rather amusing reading. Such lines as, "We hope you will continue watching our station," "This will verify receipt of your report," and, "We wish you were one of our regular viewers," pop up frequently. There's even the occasional, "No, you would not have been able to receive our station, because our new antenna transmits no sky waves."

photographing TV-DX

Perhaps this section should be subtitled, "how to get an instant QSL." What better souvenir of a DX logging could you have? TV-DXers have long been known to photograph test patterns and ID slides of



Reception is of KIIN-TV, channel 12, Iowa City by tropo. 210-miles distant.

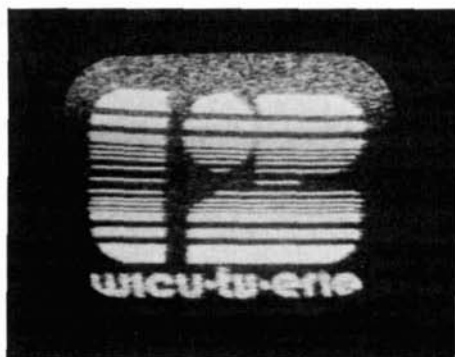

WICU-TV, Erie, Pennsylvania. 400-mile reception by tropo.

radio, these observations can also help monitor the muf. One practical application of this technique is to determine

and a high-gain parasitic array. A TV set will also work out quite well if it is used with a low-noise channel-7 mast-mounted



KTVC, channel 6, Ensign, Kansas. Received by sporadic-E at 725 miles.



Another sporadic-E catch KACB-TV, San Angelo, Texas. Two offset patterns are seen in this photo. The large black bars indicate zero offset, and the fine lines, a 20-kHz pattern. 1010-miles distant.

whether and when 2-meter sporadic-E is likely. The same is also true of auroral DX.

Several avid 2-meter meteor-scatter enthusiasts have realized that they can stay one step ahead by monitoring the activity on channel 7. As a meteor enters the earth's atmosphere, its ionized trail starts small and rapidly grows longer. Therefore, the trail more readily reflects higher than lower frequencies. In short, a meteor burst is very often heard on TV channel 7 just before it's heard on 2 meters.

For this application, there are two possible easily duplicated monitoring systems, a low-noise crystal-controlled converter tuned to about 179.25 MHz



Reception is of KOTA-TV, channel 3 in Rapid City, South Dakota, by sporadic-E. Note the fine lines indicating 20-kHz offset co-channel interference. 785-miles distant.



WCET, channel 48, Cincinnati, Ohio. A 255-mile tropo path.



Sporadic-E reception of CBHT-TV, Halifax, Nova Scotia. 1189-miles distant.

preamp.* In fact, with a TV receiver, you stand a good chance of identifying the station bursting in. Either way, the single-channel mast-mounted preamp is a great asset.

If you're looking for a vhf field-day site, a battery-powered TV set can be

your best friend. It will aid in determining how good a location is for vhf reception. Monitor some of your fringe stations at each trial site. You may find that results can be greatly enhanced by moving only a small distance.

Whenever I start thinking about the

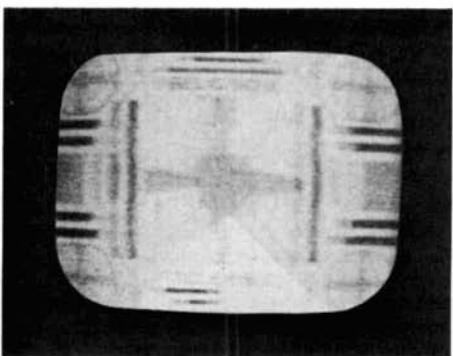
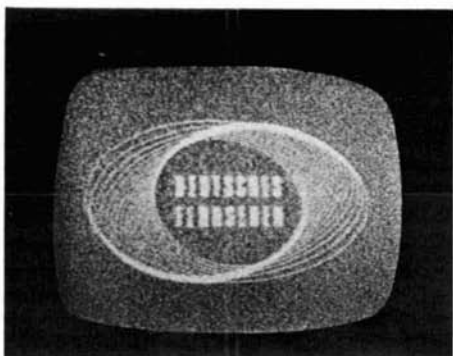

TV-DX is also popular in Europe. These photos were taken by a DXer in Holland. Top: A.R.D., West Germany, by tropo. Bottom: Belgium by tropo on channel E2.



KS2XBR, channel 38, Chicago, is one of the last experimental TV stations in the United States. This station is operated by Zenith Radio for testing pay TV devices. Truly a rare catch.

correlation between TV-DX and 6-meter propagation, I can't help remembering a rather intense sporadic-E opening that occurred several years ago. While TV DXing on channel 3, I began to hear some TVI over the TV-DX station from an

*The CADCO IPA-HB28/7 preamp is probably the unit best suited to this purpose. The noise figure of this preamp is under 1.5 dB and gain is 28 dB. Information on this preamp is available from CADCO, Inc., Box 18904M, Oklahoma City, Oklahoma 73118.

amateur in California. As if hearing double-hop TVI wasn't enough of a shock, I discovered that his signal was stronger on the TV than on 6 meters! I dropped this fellow amateur (who shall forever remain unnamed) a note, and received a reply written on the back of a QSL card. The reply stated that I was about the 50th person to complain about



Author's home station is used for TV-DX as well as for amateur communications. Note CATV-type TV monitor in upper right.

his TVI — the other 49 were his neighbors. Anyway, I was the one to finally convince him that his neighbor's TV sets weren't at fault!

TV-DX club

In the United States there is one organization devoted to TV, fm and vhf utility DX — The Worldwide TV-FM DX Association. Monthly, WTFDA publishes the *VHF-UHF Digest* which features columns devoted to member's DX reports, FCC and CRTC news, theory, construction, statistics (DX records), QSLs and

*A one-year membership in the WTFDA is \$7.00 and includes 12 monthly issues of the *VHF-UHF Digest* (for first-class mail delivery of the *Digest* the annual dues are \$9.00). Sample copies of the *VHF-UHF Digest* are available for 50 cents each, postpaid. Rates for subscribers outside the United States are available upon request. Write to the WTFDA, Box 163-H, Deerfield, Illinois 60015.

others. Feature articles frequent the winter issues. You might say that WTFDA serves the same function for non-amateur VHFers as the ARRL serves for amateur radio operators. WTFDA even holds annual conventions. This non-profit group strives at promoting vhf and uhf research and technical advancement and prides itself on its very devoted members.*

Mel Wilson, W2BOC, is a WTFDA member and credited the organization with providing detailed sporadic-E reports in the *VHF-UHF Digest*. These reports provided Mel with hard data to add to his 30+ years of propagation research.

Also well known in vhf circles for his propagation studies is Pat Dyer, WA5IYX. Pat is WTFDA's "VHF Utility DX" editor. His column covers just about every form of non-broadcast, non-amateur DX above 30 MHz. By reviewing reports in Pat's column, it is easy to follow the rise and fall of the F2 muf.

Whether or not your main interest in amateur radio lies in vhf, during the coming spring and summer months I hope that you'll keep one eye on those empty TV channels. Who knows, maybe you'll lock onto some TV-DX and get hooked, the way I did!

references

1. Del Crowell, K6RIL, and William Orr, W6SAI, "Log-Periodic Yagi Beam Antenna," *ham radio*, July, 1969, page 8.
2. Robert Cooper, W5KHT, "Interdigital Pre-amplifier and Compline Bandpass Filter for VHF and UHF," *ham radio*, August, 1970, page 6.
3. Mel Wilson, W2BOC, "Multilatitute Intense Sporadic-E Propagation," *QST*, December, 1970, page 52 (part I) and March, 1971, page 54 (part II).
4. Robert Cooper, W5KHT, "Meteor Showers: New Role in VHF DXing," *73 Magazine*, July, 1972, page 71.
5. Bill Smith, W0CER, "Using TV Station Video Carriers as Propagation Indicators," *QST*, February, 1972, page 77.
6. Edward Tilton, W1HDQ, *The Radio Amateur's VHF Manual*, ARRL, Newington, Connecticut, 1971.
7. William I. Orr, W6SAI, H.G. Johnson, W6QK1, *VHF Handbook*, Radio Publications, Inc., Wilton, Connecticut, 1956.

ham radio

The Most Powerful Antennas Under the Sun

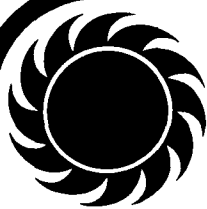

hy-gain 402BA

DX DEMON!

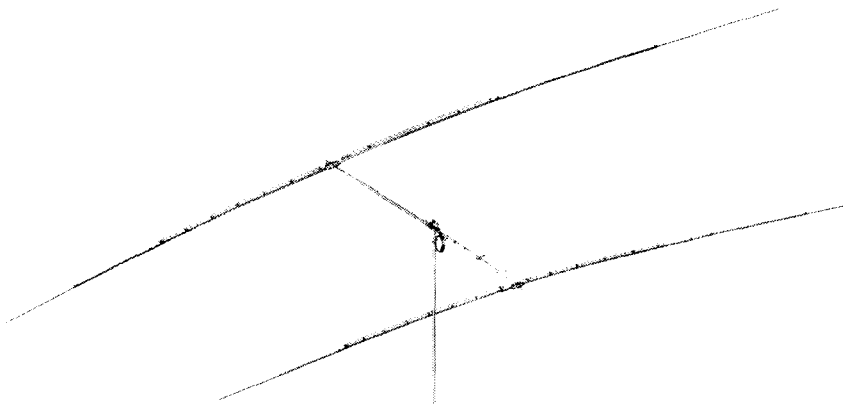

40 METERS

If 40 meters is your bag, try this one for best 40 meter performance...you'll work signals on 40 meters that you never knew existed!

The Model 402BA attenuates unwanted signals off the side and back at 12 to 25 db while amplifying signals for 4.9 db minimum forward gain. Unique linear loading stub delivers maximum performance without lossey center coils. Easily stacks with tribander or 20 meter beam; requires only 10' separation. 52 ohm feed. Beta Matched. 16 ft. boom, 43 ft. elements. Maximum power input 1 kw, AM.

Order No. 397

\$179.95

Hy-Gain 402BA...the 40 meter DX Demon!

HY-GAIN ELECTRONICS CORPORATION

Dept. WH, 8601 Northeast Highway Six
402/434-9151

Lincoln, NE 68507
Telex 48-6424

how to select batteries

for portable equipment

A discussion of
the performance
and size and cost
characteristics of
the many types
of batteries
currently available

John Nelson, WBØAIK, 700 35 Street, No. 288, Marion, Iowa 52302

Inexpensive transistors and multifunction integrated circuits have made possible a whole new generation of portable and low-power equipment for the radio amateur. They have also relieved many construction headaches for the ham who builds his own equipment. One of those headaches used to be power supply construction, but now batteries are the most popular power source because of their simplicity, low cost and portability. However, whether you build or buy your equipment, one big problem remains — selecting the batteries. The selection process may be rather involved, particularly for the builder, who has more options open to him.

battery characteristics

The first step in selecting a battery is to determine in detail the power requirements which the battery system must meet. You also should have an idea of which requirements are most important. This can be illustrated by example: Suppose you are building a portable transmitter which will use a 9-volt dc power supply. It will draw about 100 mA while transmitting and 30 mA while receiving. A list of battery parameters, in order of their importance, might look like this:

Battery voltage. This is first on the list for obvious reasons. There isn't much point in examining all the available 24-volt batteries when you only need 9 volts. But even this important parameter isn't as straightforward as a first glance might indicate. Since the output voltage of a

battery declines with operating time, you must specify the minimum and maximum supply voltages the transceiver can tolerate. Let's say that 7.2 to 10.0 volts is acceptable.

Power capability. This is almost as important as battery voltage. If the battery simply will not deliver 100 mA, it cannot be considered.

Cost. Although we all want to stretch a dollar as far as we can, you must weigh the expected battery life against its initial cost.

Size/weight. The importance of a battery's bulk will vary with the type of operating you do and the size of the radio itself. In the case of the example, you may want to trade off increased size and weight for decreased cost, if necessary. You should, however, try to stay under six pounds and 100 cubic inches.

Battery life. The economics of this parameter are covered above, but the length of time between replacements or recharges is also a matter of convenience. You may want to operate for most of a weekend without worrying about the battery giving out.

Availability. If you choose a battery type which must be replaced frequently, you must be sure that replacements are easily obtained.

Others. Some other battery parameters which are not important for the example are high and low temperature characteristics, ease of storage and long shelf life.

examining available alternatives

Let's see what is available to choose from. Since the *carbon-zinc* battery or Leclanché cell is the most widely used type of battery, and usually the least expensive, look there first. Many of the 9-volt carbon-zinc batteries are not capable of supplying 40 to 50 mA, average, for any appreciable length of time. (Estimates of battery life are based on 50 mA average current, which would correspond to transmitting for about 30% of the operating time.) One battery that will is

the Eveready 716 or the equivalent Burgess 4F6H — it should supply the transceiver for more than 300 hours. However, this battery costs over eight dollars, weighs 8½ pounds, and occupies over 200 cubic inches of space.

Another approach would be to use six common D-size flashlight cells in series. This could be the cheapest approach, but you would get less than 80 hours of battery life and battery volume would go up to about 340 cubic inches.

While I am discussing carbon-zinc batteries, I should mention the possibility of recharging them. Although such recharging can be done, it is probably not practical, and can be dangerous. Excessive gassing may result from too high charging current and the cell could explode. The following is an excerpt from National Bureau of Standards Letter Circular LC 965:

"From time to time attention has been turned to the problem of recharging dry cells. Although the dry cell is nominally considered a primary battery it may be recharged for a limited number of cycles under certain conditions. Briefly these are:

1. The operating voltage on discharge should not be below 1.0 volt per cell when battery is removed from service for charging.
2. The battery should be placed on charge very soon after removal from service.
3. The ampere-hours of recharge should be 120 - 180% of the discharge.
4. Charging rate should be low enough to distribute recharge over 12 - 16 hours.
5. Cells must be put into service soon after charging as the recharged cells have poor shelf life.

Recharging of dry cells may be economically feasible only when quantities of dry cells are used under controlled conditions with a system of exchange of used cells for new ones already in practice, and with equipment available to

provide direct current for charging. Such a system would not be practical for home use."

mercury batteries

It looks as though carbon-zinc batteries could satisfactorily fulfill the transceiver power requirements, but let's see what else is available. What about *mercury* (mercuric oxide) batteries? They

explosions. Apparently, mercury batteries will not fulfill the requirement.

alkaline batteries

The *alkaline* (alkaline-manganese) battery is becoming increasingly popular both because of its higher service capacity and because many types are rechargeable. Although the alkaline-manganese cell has the same 1.5-volt open-circuit cell voltage

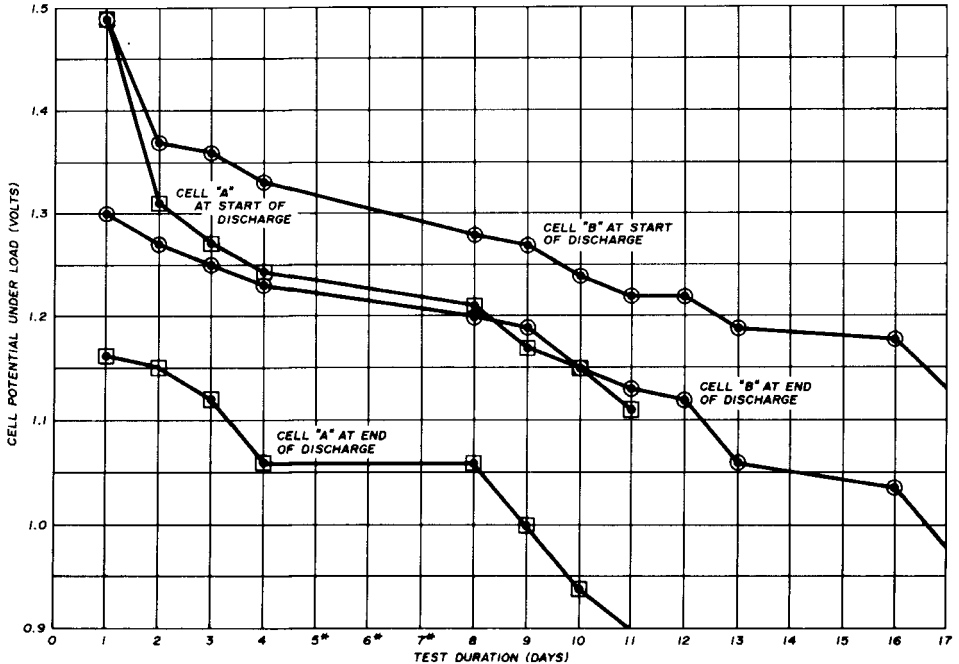

fig. 1. Comparison of two 1.5-volt carbon-zinc cells, discharged 3½ hours per day into a 10-ohm load. Cell A is a low-cost unit while Cell B is a so-called super cell, manufactured by a well-known company. On days marked with an asterisk the cells were not discharged.

have the advantages of a very stable cell potential and high power capability for a smaller size. They are also expensive.

Since a single 9-volt battery of sufficient power capacity is not readily available, let's look at six D-size cells (such as the Eveready E42) in series. Here you could approach 300 hours of operation, but at a cost of about thirty dollars and with a volume exceeding 300 cubic inches. Although it is possible to recharge mercury cells, decreasing the overall operating cost, manufacturers discourage the practice because of the danger of cell

as the carbon-zinc cell, it discharges at lower voltages. The carbon-zinc cell provides most of its available energy above 1.25 volts and will be just about exhausted at 1.0 volt. However, the alkaline-manganese cell yields most of its energy below 1.25 volts and still has quite a reserve below 1.0 volt.

This means that if you use six alkaline-manganese cells for the 9-volt transceiver power supply, you should expect a significant percentage of operation to be at 6 volts or less. Such a supply voltage drop would not be acceptable for the

transceiver in the example. However, if the system is to be recharged, discharge is usually terminated at about 1.1 volts. Thus, a rechargeable alkaline battery system would provide acceptable operating voltages.

I found no readily available 9-volt alkaline batteries, but rechargeable 1.5-volt D-cells are easily obtained. Six of these cells should cost about ten dollars

might be expected, all these good things do not come cheap. Nickel-cadmium D-size cells for use in the transceiver would cost over six dollars each, and would be just as bulky as the other types.

Another alternative would be to use a 10-volt nickel-cadmium battery such as the Eveready 1007 power pack. This unit weighs less than 4 pounds and only takes up about 63 cubic inches of space. For

table 1. Performance and cost of batteries used for a 9-volt power supply.

type	size (cubic inches)	weight (lb.)	estimated life (hours)		cost	
			per charge	total	initial	per 100 hours
9 volt carbon-zinc (Eveready 716, Burgess 4F6H)	204	8½	310	310	\$ 8.95	\$ 2.90
Six 1.5 volt carbon-zinc D cells	345	1½	280	280	\$ 1.50	\$ 1.90
Six 1.35 volt mercury D cells	345	3	280	280	\$30.00	\$11.00
Six 1.5 volt alkaline recharge- able D cells	345	2	40	2000*	\$10.00	\$.50
10-volt nickel- cadmium (Eveready 1007)	63	4	80	40,000†	\$40.00	\$.10

*Based on an estimated 50 cycle life

†Based on an estimated 500 cycle life

and should last 30 - 40 hours between recharges. If battery life is 50 recharge cycles, then the initial investment should be good for nearly 2000 hours. The recharge operation can be simplified by purchasing one of the special chargers which are generally available for less than ten dollars. Size and weight are about the same as carbon-zinc D-cells. Rechargeable alkaline batteries are definitely among the possibilities for powering the transceiver.

nickel-cadmium batteries

When you discuss rechargeable batteries, everybody thinks of *nickel-cadmium* batteries. This popular battery has led to the development of a tremendous variety of cordless, rechargeable devices because they combine the ease of portability with the freedom from having to buy fresh batteries everytime you turn around. As

operation between 9.0 and 10.0 volts, capacity between recharges would be about 80 hours. The initial cost of nearly forty dollars sounds pretty steep until you realize that the recharge cycle life of this unit is upwards of 500 cycles if care is taken to avoid over-discharge and if recharging is performed regularly. This represents over 40,000 hours of available power!

Recharging is easily accomplished with the aid of the Eveready 1807 charger, available for under ten dollars. Depending upon your store of ready cash and your eye for long-haul economy, this type of battery system could be the best selection.

lead-acid batteries

One other battery which should be mentioned is the familiar automotive-

type *lead-acid* battery. It has the advantage of being readily available and easily recharged for many, many cycles. Although it may be useful for some semi-portable or mobile applications, I would not seriously consider it for the example transceiver because of its objectionable bulk and messy liquid electrolyte.

making the choice

Looking at **table 1**, it is easy to see that the selection must be based on

getting a better cell than the cheaper *Brand X*?

To satisfy my own curiosity I bought two cells and conducted a simple test. Cell A was sold under the name of a popular discount department store at 34 cents for a pair. Cell B was a *Super Cell* manufactured by one of the well-known battery companies. It had 39 cents stamped on one end but was purchased in the same store for 48 cents per pair.

The test consisted of discharging the

table 2. Battery manufacturers. Most of these firms will provide information on the performance and recommended use of their batteries.

General Electric Co.
Battery Products Division
P.O. Box 114
Gainesville, Florida 32601

Mallory Battery Company
Broadway and Sunnyside Lane
Tarrytown, New York 10591

Gould, Inc.
Burgess Division
P.O. Box 3140
St. Paul, Minnesota 55165

Sonotone Corp.
Battery Division
Saw Mill River Road
Elmsford, New York 10523

Gulton Industries, Inc.
Battery and Power Sources Division
212 Durham Avenue
Metuchen, New Jersey 08840

Union Carbide Corp.
Consumer Products Division 270 Park Avenue
New York, New York 10017

tradeoffs. The problem seems to reduce to choosing between six carbon-zinc D cells and the 10-volt nickel-cadmium power pack. In the case of the carbon-zinc D cells you get the lowest weight, least initial cost and a reasonable cost per hour. In the case of the nickel-cadmium power pack you get the smallest size and lowest extended cost per hour.

Which is best? That depends on your particular circumstances. For the transceiver let's choose the six carbon-zinc D cells, trading off increased bulk and higher long-term cost for the small initial cost. **Table 1** also indicates that rechargeable alkaline D cells would be an attractive compromise selection.

The selection process is now almost complete. The friendly neighborhood drugstore has several different brands and prices from which to choose. If you pay a premium for the *Super Long-Lasting Heavy-Duty Power Cell* are you really

two cells into ten-ohm loads for about 3½ hours each day. Cell voltages were measured at the beginning and end of each discharge period and are displayed graphically in **fig. 1**. Note the recovery in cell potential after the cells are "rested." You can see from **fig. 1** that cell B will last more than twice as long as cell A and is therefore the better buy in this case. In general, it probably pays to buy the more expensive batteries, even if only for the convenience of less frequent replacements.

conclusion

It should be obvious from this discussion that one of the requirements for intelligent battery selection is sufficient information on the available choices. **Table 2** lists the names and addresses of several battery manufacturers from which further information may be obtained.

ham radio

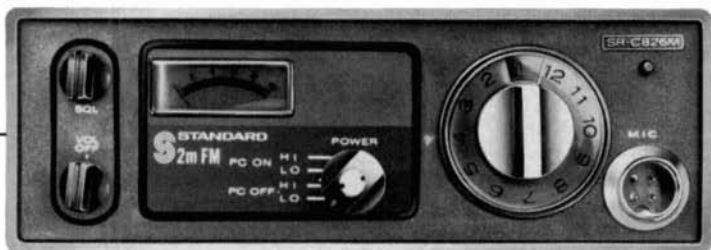

MAXIMIZE YOUR AMATEUR RADIO

What new 2M FM gives **MONEY.** that assures: top selectivity, great sensitivity, and rejection of unwanted signals on today's active 2M band. **Helical Resonators** & FET front end provide the performance needed for tomorrows crowded channels. Provision for **tone coded squelch** to activate modern repeaters. A radio that won't become obsolete. Occupies less than 200 cu. in. Weighs less than 5 lbs. It has all the same "Astropoints" as entire Amateur line.

What new 2M FM gives me most for my money, performance vs. price? The answer's as clear as the superb reception you'll get on the new Standard 826MA, 10 watt, 2 meter FM transceiver. You'll find such outstanding features as 12 channels — with the four most popular ones included — and a RF output meter with selection of 10 watts or 0.8 watt for battery conservation. And of course, our "Astropoint" system

NEW 22 CHANNEL BASE STATION SRC-14U

Ultimate in a 2M FM Transceiver features:

- 22 channels
- AC & DC supplies Built In
- 10W (1, 3 & 10 selectable)
- Receiver offset tuning
- VOX
- Three Front Panel Meters
- Plus many more exciting features.



For detailed information on these; the complete Standard line and the name of your nearest dealer write:



Standard
Communications Corp.

213 / 775-6284 · 639 North Marine Avenue, Wilmington, California 90744

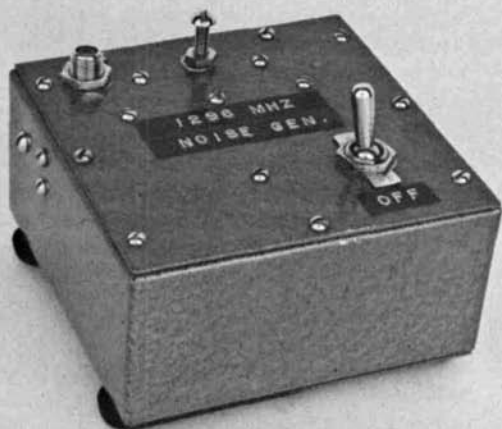

1296-MHz noise generator

Construction details
for a simple diode
noise generator
for optimizing
receiver performance
on 1296 MHz

Cy Dirickson, W3BSV, 714 South Park Drive, Salisbury, Maryland

A **noise generator** is an extremely useful item to have around the shack for checking out your latest uhf preamplifiers or converters. This is particularly true on 1296 MHz where best low-noise performance must be obtained for practical, long-distance communications. The noise generator can also be used to check coaxial cable loss and transmit-receive relay loss by simply reading the values from your receiver's S-meter.

The output of the simple 1296-MHz noise generator described here is just

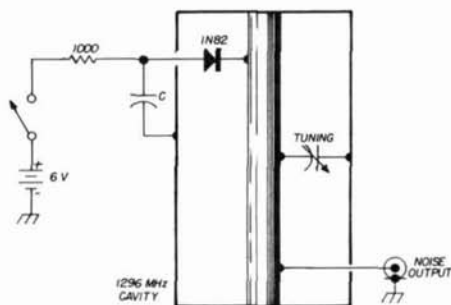

fig. 1. Simplified schematic of the 1296-MHz noise generator. Construction details are shown in fig. 2.

detectable on the average 1296-MHz mixer, and when fed through a K5200/K5500 rf amplifier, will show a gain of three S-units above internal noise. This represents approximately 18 dB.

construction

The 1296-MHz noise generator is built into a Bud 4x4x2-inch aluminum chassis with a bottom plate. All but one wall of the 1296-MHz trough line are provided by the chassis; the remaining partition is made from thin brass or copper sheet and attached to the chassis with 6-32 screws.

Both ends of the 1/4-inch brass rod used in the cavity are drilled and tapped for 6-32 screws. This rod is mounted in the center of the trough line with 6-32 screws, as shown in fig. 2. The 1N82 noise diode is tapped 1-inch down from

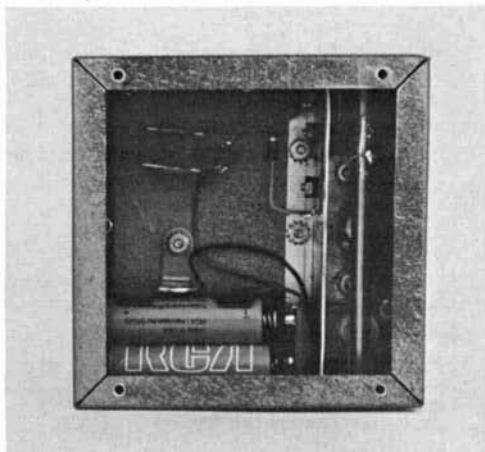

Construction of the noise generator.

the top of the line. The output BNC connector is connected to the bottom of the line with a 1/4-inch wide copper strap, 1-inch long. The copper strap runs parallel to the line as shown in the construction diagram.

Although the BNC connector is shown on the side of the cavity for the purposes of this diagram, it is actually located underneath the trough line, directly opposite the 8-32 tuning screw.

The 8-32 tuning screw runs through a nut which is soldered to a thin, 2x3/4-inch brass plate which is attached to the aluminum chassis with screws. An 8-32 nut is used as the tuning disc. Another 8-32 nut is used for locking the tuning screw after the noise generator has been adjusted for maximum output at 1296 MHz.

The bypass capacitor consists of a 1-1/2x1-inch piece of thin brass, folded over into a U-shape and soldered to the side of the inside partition. Another small piece of brass sheet, about 1-inch square, is inserted into the U-shaped piece, as shown in fig. 2. Thin teflon sheet is used for the dielectric.

Power to the noise diode is provided by four 1-1/2-volt penlight cells, mounted in a compact battery holder. The spst toggle switch is mounted on the top of the enclosure.

ham radio

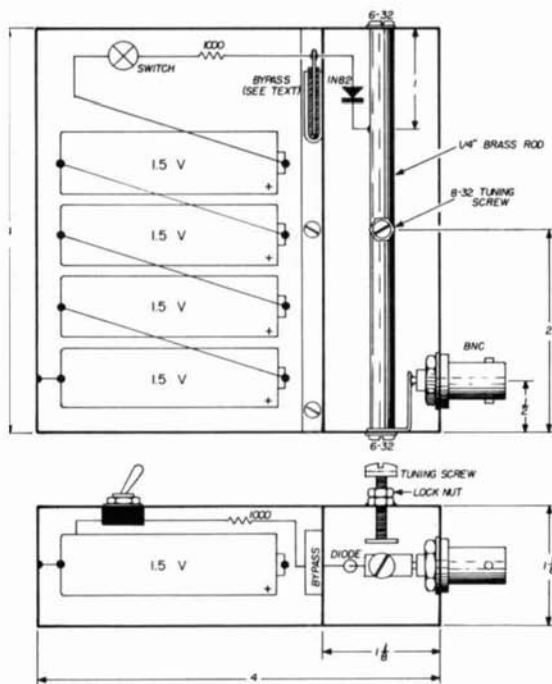
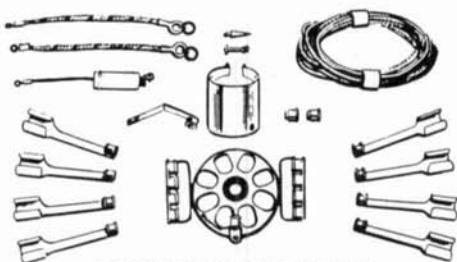

fig. 2. Construction of the 1296-MHz noise generator. Output BNC connector is actually located underneath the trough line, opposite the tuning screw, but is shown on the side, here, for clarity.

HALLETT ELIMINOISE

Ignition Noise Suppression Kit



MODEL 80 - UNIVERSAL KIT FITS ALL 8 CYL. AMERICAN CARS

LIMITED

SPECIAL \$24.95

\$55.00 VALUE

Add \$2.50 for shipping & handling

LA Tronix

6 and 2 Meter

Sale Priced **15⁹⁵**

Gutter Mount Version \$19.95

MODEL LA 150A

Gain (2 Meters)3db
Gain (6 Meters)Unity
Nominal Impedance 55 ohms
Overall Length55 in.

Add \$2.50 for shipping & handling

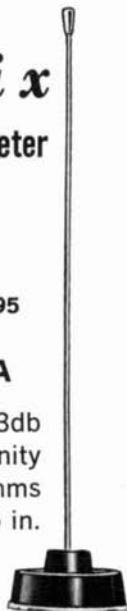

BONUS THE BEST ANTENNA PACKAGES YET!

LAE W51 "DELUXE" 51 Ft. Package
(Free Standing, 9 Sq. Ft. - 50 MPH)
CDR TR-44 rotor*
100 ft. RG58A/U coax cable
100 ft. control cable

Complete with one of the following antennas:

HY-GAIN DB 10-15A	\$620
HY-GAIN HY QUAD	\$650
HY-GAIN 204BA	\$660
HY-GAIN TH3MK3	\$655
HY-GAIN TH6DXX	\$675

Free stdg. base incld. NO/CHARGE
*HAM-M rotor w/RG8/U add: \$ 60
FRT. PREPAID CONT. USA

A "broadband" isn't an all girl orchestra.

ITS A BALUN FROM LA-TRONIX



Mod. LA-BN330

IMPROVE YOUR ANTENNA PATTERN AND REDUCE TVI.....FOR ONLY

\$11.77

SPECIFICATIONS

BANDWIDTH.....3 THROUGH 30 MH. CONTINUOUS
VSWR.....1:1 WHEN TERMINATED WITH A BALANCED 52 OHM LOAD.
POWER RATING.....1KW DC 2KW PEP
IMPEDANCE RATIO.....1:1 AT 52 OHMS
INPUT CONNECTOR.....SO-239
OUTPUT CONNECTIONS.....STANDARD TERMINAL LUGS
WEATHER PROTECTION.....INTERNALLY SEALED

Add \$1.00 for shipping & handling

"WE SELL ONLY THE BEST"

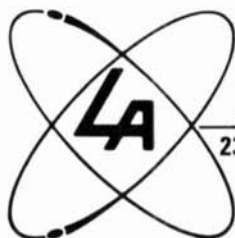

Electronix Sales

23044 S. CRENSHAW BLVD., TORRANCE, CALIF. 90505

Phone: (213) 534-4402

HOME of LA AMATEUR RADIO SALES

BONUS OFFER

**FREE
CALCULATOR!!*
YOUR CHOICE!!**

HAND-HELD MEMORY CALCULATOR

\$129.95 Value

*WITH ANY PURCHASE OVER \$599 MFG. LIST PRICE

SPECIFICATIONS

1. Adds, subtracts, multiplies and divides . . . performs chain and mixed calculations.
2. True memory, selectively stores and recalls in separate register.
3. Automatic percentage calculation.
4. Automatic constants in multiplication and division; plus repeat addition and subtraction.
5. Floating decimal.
6. Add-mode presets for dollars and cents.
7. Bright, clear LED display.
8. AC/DC operation; complete with disposable pen-light batteries and carrying case; compatible with standard, optional adapter and rechargeable batteries.
9. Weighs only 8 oz. and is 5¼" x 2¾" x 1¼".
10. One year over-the-counter exchange guarantee.



12 DIGIT ELECTRONIC CALCULATOR WITH MEMORY

SPECIFICATIONS

1. Adds, subtracts, multiplies and divides . . . performs chain and mixed calculations.
2. True memory selectively stores and accumulates in separate register.
3. Credit balance results in both working and memory registers.
4. Floating decimal for entries; pre-selection 0, 2, 4, 6 decimals for answers.
5. Automatic constants in multiplication and division.
6. Selective round-off to 5/4.
7. Reverse key selectively changes a dividend to a divisor; changes sign without clear and re-entry.
8. Overflow, credit balance and memory-in-use light indicators.
9. Suppression of unwanted zeros.
10. Weighs 3 lbs. and is only 7½" x 9½" x 2½".
11. One year over-the-counter exchange guarantee.



WRITE FOR OUR LOW DISCOUNT PRICES!!



Electronic Sales

23044 S. CRENSHAW BLVD., TORRANCE, CALIF. 90505

Phone: (213) 534-4402

"THE WEST COAST'S LARGEST ANTENNA SUPPLIER"

inexpensive all-channel frequency synthesizer for two-meter fm

How to obtain
sixteen vhf
fm channels,
spaced 30 kHz,
with only four
inexpensive crystals

Jim Fahnestock, W0OA, Box 1355, Evergreen, Colorado 80439

One of the not-so-hidden expenses in two-meter fm operation is the cost of crystals. For 12-channels in some transceivers, the cost of crystals is nearly as much as the cost of the transceiver itself! And, on occasion, your desired operating frequency may *not* be among the 12 channels that cost so much to acquire.

The frequency synthesizer described here can produce 16 fm channels, spaced 30 kHz, with just *four* inexpensive crystals. With nine crystals all 36 channels from 145.98 to 147.03 can be synthesized. In addition, a five-crystal receiver local-oscillator synthesizer is suggested, covering all channels from 146.34 to 147.06 in 30-kHz steps.

The concept is quite simple, though different from (and much simpler than) conventional synthesizers. The idea has been *tried* on paper and appears to present no difficult problems. At the time of this writing a number of construction projects are in the works using ICs. One circuit uses four ICs, four crystals and two simple filters to produce 16 channels for repeater inputs. Another circuit uses eight crystals to provide 32 channels, permitting repeater *or* simplex operation on all commonly-used channels — and then some.

transmitter synthesizer

The basic block diagram of the transmitter synthesizer is shown in **fig. 1**. With

four crystals, all channels from 145.98 to 146.43 are covered, providing inputs for most repeaters with a transmitter that multiplies 24 times.

The upper half of table 1 shows the operating frequencies provided by the circuit of fig. 1. With five extra crystals, F_E through F_1 , all channels from 145.98 to 147.03 are available in 30-kHz steps.

An alternate eight-crystal version is shown in fig. 2 and the available transmit-

obtain the 24th subharmonic of the desired operating frequency. Multiplication is done in conventional fashion in the transmitter. The synthesizer simply serves as a substitute for the usual transmit crystals.

For example, suppose a frequency of 146.34 is desired. Referring to fig. 1 and table 1, this choice calls for mixing the fundamental of crystal D ($F_D = 8.130$ MHz) with the 4th subharmonic of crystal D ($F_1 = 8.130/4 = 2.0325$ MHz). The mixer extracts the *difference* between these two frequencies, $8.130 - 2.0325 = 6.0975$, which, when multiplied 24 times in the transmitter, yields the desired output frequency, $6.0975 \times 24 = 146.34$ MHz.

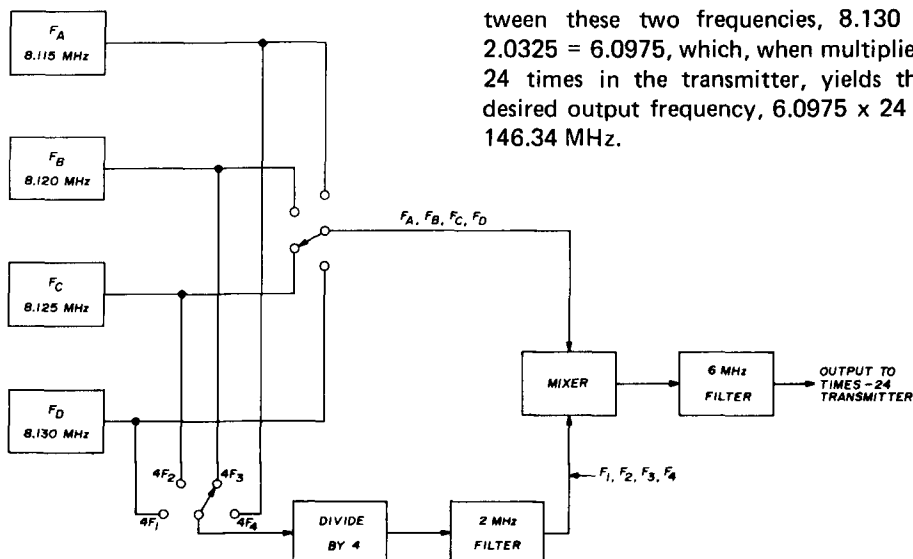

fig. 1. Suggested circuit for a 4-crystal, 16-frequency synthesizer to cover repeater input channels from 145.98 to 146.43 MHz. See table 1 for frequency combinations.

ting frequencies include all but 146.46 through 146.55 MHz. In fig. 2, the operating channels would be from 146.58 to 147.03 (16 channels) and the transmitter would be set to transmit *on channel* or 600 kHz below for repeater operation, simply by setting the *repeat simplex* switch in the appropriate position.

As shown in fig. 1, one crystal fundamental frequency is mixed with the fourth subharmonic (easily obtained with a single dual-JK flip-flop) of either the same or one of the other crystals to

The sixteen possible combinations of the four crystal frequencies and their 4th subharmonics provide the 16 repeater input channels as shown in table 1. Using 4th subharmonics of the same four crystals, but fundamentals of those shown in the simplex position, fig. 2, simplex operation is available.

Fortunately, 8-MHz crystals are inexpensive and easy to use. Garden variety crystals can be *rubbered* to the correct frequency in a variety of ways. If a high-frequency digital counter is available either the fundamental or the fourth

subharmonic of each crystal can be measured and adjusted. An accurate receiver or frequency meter capable of tuning 8 MHz or 2 MHz can also be used.

Notice that crystal D ($F_D = 8130$ kHz) can be set by the discriminator of a 146.34-MHz receiver since it is the only

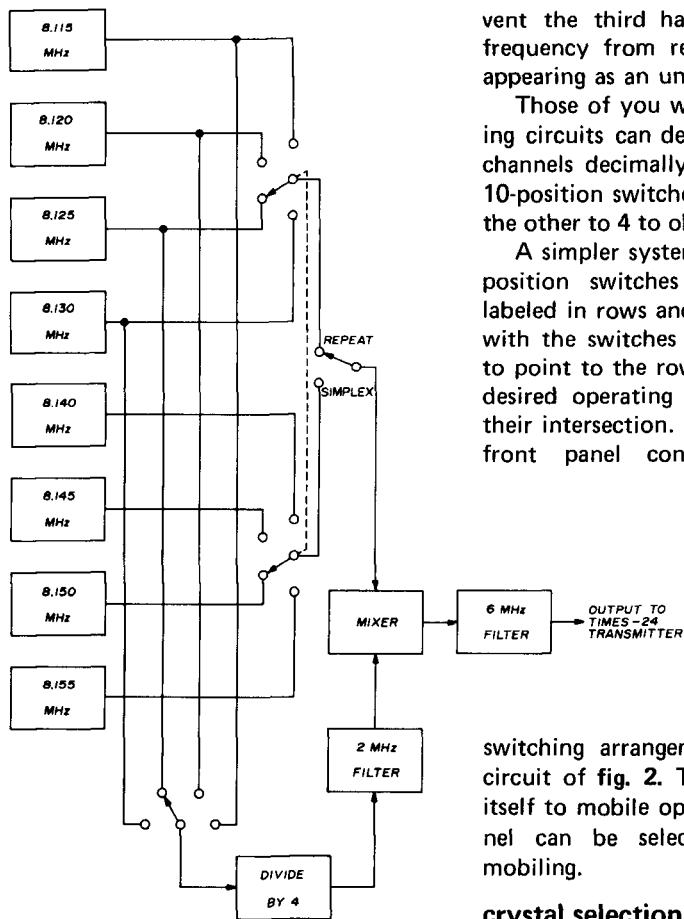

fig. 2. Circuit for repeater and simplex operation uses eight crystals for 32 transmit channels.

crystal used in generating that frequency. Likewise, crystals C, B and A can be adjusted with receivers on 146.25, 146.16 and 146.07 MHz. If the receivers are on frequency, all the other frequencies will be.

It should be noticed that all 16 frequencies are the result of either one or

two crystals. This may require that two oscillators be operating simultaneously. Obviously, good isolation must be provided between oscillators to prevent the fundamental of the crystal whose 4th subharmonic is being used from reaching the mixer and producing a spurious signal.

The 2-MHz filter is necessary to prevent the third harmonic of the 2-MHz frequency from reaching the mixer and appearing as an unwanted 6-MHz output.

Those of you who are adept at switching circuits can design a system to select channels decimally, that is, to have two 10-position switches, setting one to 3 and the other to 4 to obtain 146.34 MHz.

A simpler system would use two four-position switches and a printed card labeled in rows and columns as in table 1 with the switches arranged mechanically to point to the row and column with the desired operating (receive) frequency at their intersection. Fig. 3 shows a possible front panel configuration using the

switching arrangement suggested in the circuit of fig. 2. This arrangement lends itself to mobile operation since the channel can be selected by "feel" while mobiling.

crystal selection

At first glance, it might seem that the selection of crystal frequencies was somewhat arbitrary. However, there is just one set of frequencies that will give the desired operating frequencies and channel spacing for a given transmitter multiplication factor.

Several conditions must be met simultaneously. First, the *difference* between the selected fundamental frequencies and selected 4th subharmonic frequencies must be 1/24th the operating frequency

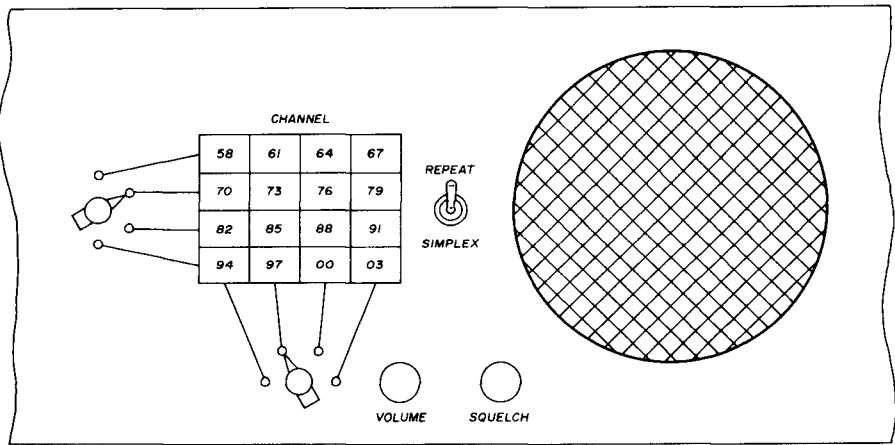

fig. 3. Suggested front panel layout for 32-channel transceiver shown in fig. 2.

for a 24 times transmitter. Second, the crystal subharmonic frequency *steps* must equal the desired channel spacing divided by the multiplication factor; since these frequencies are derived from the crystal fundamental frequencies, this determines the steps required of the crystal frequencies.

Since the goal is 30-kHz spacing in the 146-MHz region, the crystal subharmonic frequencies must be spaced $0.03/24 = 0.00125$ MHz. The fundamentals must be spaced four times that, or 0.005 MHz.

The lowest operating frequency (in this case 145.98 MHz) will result from mixing the *lowest* crystal fundamental frequency with the *highest* subharmonic

(the *difference* between the two determining the transmitting frequency). Crystal frequencies can be computed as follows:

$$F_A - \frac{F_D}{4} = \frac{\text{Lowest Frequency}}{\text{Multiplication Factor}} \quad (1)$$

Since the crystal fundamental frequencies must be spaced 0.005 MHz, and there are three *spaces* between F_A and F_D , then

$$F_D = F_A + 3 \times 0.005 = F_A + 0.015 \quad (2)$$

using this value for F_D in eq. 1 yields

$$F_A - \frac{(F_A + 0.015)}{4} = \frac{145.98}{24}$$

Solving for F_A , we obtain the 8.115

table 1. Transmitting frequencies for combinations of fundamental and 4th subharmonic frequencies. Four-crystal version covers channels above dashed lines. Eight-crystal version covers all channels except those between dashed lines. Nine-crystal version covers all channels from 145.98 to 147.04 MHz.

crystal frequencies	$F_1 = \frac{FD}{4} =$ 2.0325 MHz	$F_2 = \frac{FC}{4} =$ 2.03125 MHz	$F_3 = \frac{FB}{4} =$ 2.030 MHz	$F_4 = \frac{FA}{4} =$ 2.02875 MHz
$F_A = 8.115$ MHz	145.98	146.01	146.04	146.07
$F_B = 8.120$ MHz	146.10	146.13	146.16	146.19
$F_C = 8.125$ MHz	146.22	146.25	146.28	146.31
$F_D = 8.130$ MHz	146.34	146.37	146.40	146.43
		see text		
$F_E = 8.135$ MHz	146.46	146.49	146.52	146.55
$F_F = 8.140$ MHz	146.58	146.61	146.64	146.67
$F_G = 8.145$ MHz	146.70	146.73	146.76	146.79
$F_H = 8.150$ MHz	146.82	146.85	146.88	146.91
$F_I = 8.155$ MHz	146.94	146.97	147.00	147.03

MHz shown in **table 1**. Frequencies F_B , F_C and so on are obtained by successively adding 0.005 MHz for each fundamental frequency. To add the channels 146.46 through 146.55, a fundamental crystal of 8135 would be added with appropriate switching provisions.

It will be noticed that only subharmonics of F_A through F_D are used. You might be tempted to try a 5x5 matrix (or even a 6x6) to obtain additional channels with fewer crystals, but the frequencies

table 1. No measurements have been made to determine the coupling between circuits. The 7473 dual-JK flip-flop makes an ideal divide-by-4 circuit and provides sufficient output to be heard in a Drake R4-A receiver equipped with a crystal for the 2.0- to 2.5-MHz band. Frequencies thus checked were right on.

The 2-MHz filter will probably consist of a parallel tuned circuit at 2 MHz and possibly a 6-MHz parallel circuit in series with the lead to the mixer to prevent the 3rd harmonic of the 2-MHz signal from reaching the mixer (the output of the divide-by-4 circuit is a square wave and will be rich in harmonics, suggesting careful attention to this potential source of spurious signals).

receiver frequency control

Naturally, the question arises, what about the receiver? There are several possible approaches. Probably the most simple is a tunable receiver (remember those?) with which the operator "finds" the repeater output or the 24th harmonic of a simplex frequency output, possibly with a *tune*

position that activates only the synthesizer.

The circuit of **fig. 5** illustrates another possibility. Here, the output of the synthesizer is multiplied 8 times (assuming a receiver with a local oscillator multiplication factor of three) and mixed with a crystal-controlled oscillator whose frequency is

$$F = \frac{F_{if} - F_{ro}}{3} \quad (3)$$

Where F_{if} is the first intermediate frequency of the receiver and F_{ro} is the

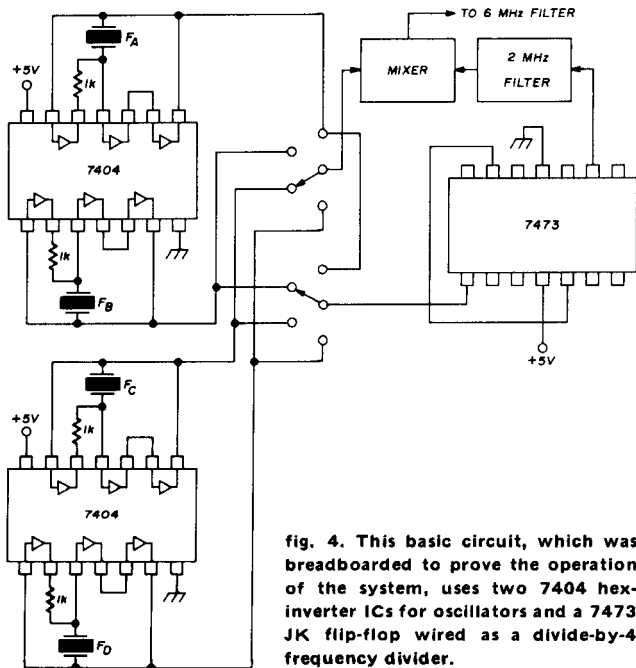

fig. 4. This basic circuit, which was breadboarded to prove the operation of the system, uses two 7404 hex-inverter ICs for oscillators and a 7473 JK flip-flop wired as a divide-by-4 frequency divider.

become unwieldy and mixing problems arise. Getting 36 crystal-controlled channels with only 9 crystals isn't a bad compromise!

practical circuit

With no IC experience and even less equipment, I have managed to implement some of the functions illustrated in the foregoing block diagrams using readily-available and inexpensive ICs (see **fig. 4**). The 7404 hex inverter affords two oscillators in the circuit shown using series-resonant crystals of the values shown in

table 2. Frequencies for receiver synthesizer using 10.7-MHz i-f and times-three receiver local-oscillator multiplication factor. Five crystals permit reception of 25 channels from 146.34 to 147.06 MHz.

	$F_1 = 5F_E$	$F_2 = 5F_D$	$F_3 = 5F_C$	$F_4 = 5F_B$	$F_5 = 5F_A$
	56.7667	56.7167	56.6667	56.6167	56.5667
$F_A = 11.3133$	147.06	146.91	146.76	146.61	146.46
$F_B = 11.3233$	147.03	146.88	146.73	146.58	146.43
$F_C = 11.3333$	147.00	146.85	146.70	146.55	146.40
$F_D = 11.3433$	146.97	146.82	146.67	146.52	146.37
$F_E = 11.3533$	146.94	146.79	146.64	146.49	146.34

repeater offset (usually 600 kHz). For the normal 600-kHz offset and a 10.7-MHz i-f, the frequency would be

$$F = \frac{10.7 - 0.6}{3} = 3.3667 \text{ MHz}$$

For simplex operation $F_{ro} = 0$ and $F = 10.7/3 = 3.5667$ MHz. Switching could be tied to the *repeat simplex* switch shown in figs. 2 and 3.

For the 34/94 situation, the synthesizer output of $6.0975 \times 8 = 48.78$ MHz, which, when mixed with 3.3667 MHz, yields a difference frequency of 45.4133 MHz. Multiplying this three times in the receiver results in the desired local oscillator frequency of 136.24 MHz which is 10.7 MHz below 146.94. The 45-MHz filter is necessary to eliminate the *sum* of

the frequencies being mixed in the circuit.

A slight modification of the matrix synthesizer described above can be used to generate local-oscillator frequencies for an all-channel receiver (see fig. 6). This technique lends itself to automatic scanning using a 5x5 matrix sequenced by two 5-bit shift registers.

Here, a 5x5 matrix is possible which generates local-oscillator frequencies for 25 receive channels from 146.34 to 147.06 MHz with only five crystals. Because the desired frequencies (to substitute for the receiver's first local-oscillator crystals) are higher in the receiver case, it becomes convenient to *multiply* the synthesizer crystal fundamental frequencies rather than to divide, as in the case of the transmitter synthesizer. The crystal formula is

$$F_1 - F_A = \frac{\text{highest frequency} - \text{receiver i-f}}{\text{receiver multiplier}} \quad (4)$$

but F_1 is the 5th harmonic of F_E , which must be 0.04 MHz higher than F_A for proper channel spacing (by the same reasoning used in the transmitter version) so $F_1 = 5F_E = 5(F_A + 0.04)$. Substituting in the above equation

$$F_A = 5(F_A + 0.04) - F_A$$

$$= \frac{147.06 - 10.7}{3} = 11.3135 \text{ MHz}$$

Other frequencies in the 5x5 receiver matrix are shown in table 2.

Here again, precautions must be taken

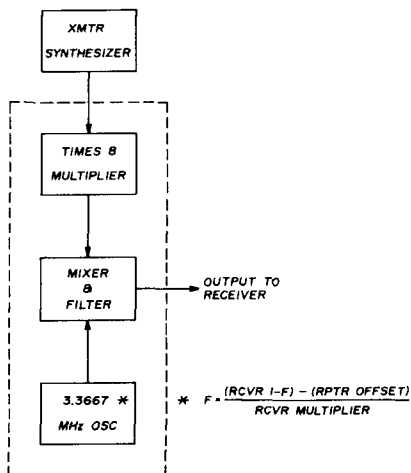

fig. 5. Tracking receiver local-oscillator frequencies can be obtained for repeater operation using this circuit. If reception is required on normal repeater input channels, 3.5667 MHz is substituted for the 3.3667 MHz frequency shown.

CRYSTAL FILTERS and DISCRIMINATORS

by K.V.G.

10.7 MHz FILTERS

XF107-A	14kHz	NBFM	\$38.25
XF107-B	16kHz	NBFM	\$35.55
XF107-C	32kHz	WBFM	\$35.55
XF107-D	38kHz	WBFM	\$38.25
XM107-S04	14kHz	NBFM	\$16.75

(4 pole, in HC6/U crystal can)

CRYSTAL SOCKET (for XM107-S04) type DG1
\$1.50

10.7 MHz DISCRIMINATORS

XD107-01	30kHz	NBFM	\$20.20
XD107-02	50kHz	WBFM	\$19.30

VARACTOR

VHF TRIPLERS UHF

MMv 432 \$69.95

INPUT: 140-153 MHz
20 watts max.

OUTPUT: 420-459 MHz
12 watts min.

Size: 4 1/2" x 2 1/2" x 1 1/4" + Connectors

MMv 1296 \$79.95

New Increased Power Ratings

INPUT: 420-459 MHz
20 watts max.

OUTPUT: 1260-1377 MHz
12 watts min.

Size: 4 1/2" x 2 1/2" x 1 1/4" + Connectors

Write for details on
our **NEW 1296 MHz Converter**

Only **\$69.95**

si

**SPECTRUM
INTERNATIONAL
BOX 1084 CONCORD
MASSACHUSETTS 01742**

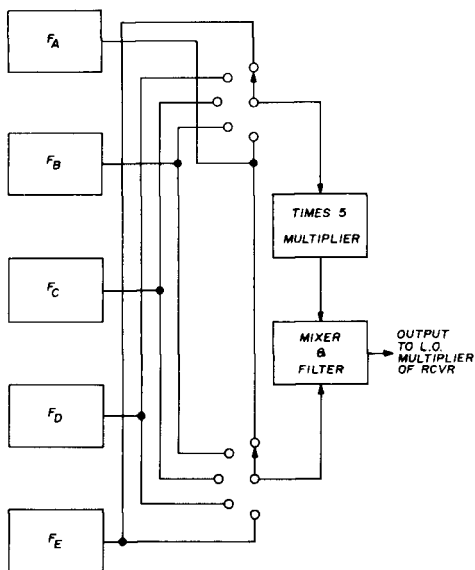

fig. 6. Suggested 5-crystal, 25-channel receiver local-oscillator synthesizer covering 146.70 through 146.34 MHz in 30-kHz steps. See table 2 for frequencies and crystal frequencies.

to minimize birdies and other spurious signals. For example, assume F_A and F_1 are being mixed to obtain the proper local-oscillator frequency to receive 147.06 MHz $(56.7665 - 11.3113)/3 = 136.3896$ MHz. It will be noticed that the 12th harmonic of 11.3133 MHz is 135.7596, which, if present in the receiver mixer, will admit a strong signal on 146.46. So, good filtering and isolation are important in designing a receiver around this matrix.

Although 10.7-MHz intermediate frequencies have been used as examples in this article, versions are possible for surplus equipment. Naturally, attention will have to be given to matching the outputs of these circuits to the requirements of the equipment to be used, but more difficult problems have been solved by ham ingenuity before and they should be solvable in this instance.

It is hoped that this idea article will inspire some interesting construction projects and promote more flexible and economical two-meter fm operation in general.

ham radio

LIKE FM OR CW ?



*Then you'll love
Data Engineering's
new catalog*

Write for your free copy today!

TOUCH TONE PADS

More features than any other pad including built-in monitor speaker and latest Phase-Lock loop circuitry.

TTP-1 Standard pad for portable transceiver mounting.

TTP-2 Standard pad in attractive case for home or mobile use.

TTP-3 Mini-pad in attractive case for home or mobile use.

TTP-4 Mini-pad for portable transceiver mounting.

TTP-1, 2, 3 & 4, Sh. wt. 1 lb. \$44.50

TTP-1K, 2K, 3K & 4K, Sh. wt. 1 lb. \$34.50

AUTO-PATCH CONSOLE

This mobile or home console includes all the features you need for complete auto-patch operation. A Touch-Tone Pad; an automatic dialer for sending one access code plus five Touch-Tone phone numbers; a single/dual tone burst encoder adjusted to your choice of frequency above 500 Hz, a continuous sub-audible tone encoder, and a built-in monitor. Complete PTT operation with one second transmitter hold. Sh. wt. 2 lbs.

APC-4K Comp. Kit \$84.50 APC-4 Assembled \$98.50

2-METER PREAMP

Specially made for both OLD and NEW receivers. The smallest and most powerful preamp available. Provides 20dB gain at 2.5 N.F. to bring in the weakest signals.

Sh. wt. 4 oz. \$9.50 kit
\$12.50 wired

Please include sufficient postage for shipping.



DATA ENGINEERING INC.



Ravenswood Industrial Park, Springfield, Va. 22151

5554 Port Royal Road • 703-321-7171

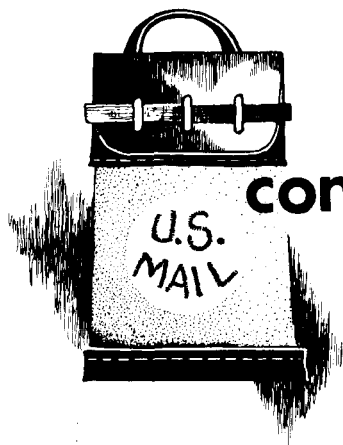

comments

speech clipping

Dear HR:

I wish to make a few comments on G6XN's article on speech clipping. He states, "the clipping level should be sharply defined," but does not give a reason for this. Any nonlinearity in a system creates distortion and rounded corners on the envelope would create a low order product, increasing the possibility of the product falling within the passband. An audio or rf compressor should precede the clipper to keep the clipping level constant as normal speech inflections (and emphasis on certain syllables) amount to 10 or 15 dB. How you can keep the clipping level constant without one is beyond me.

G6XN discusses filter shape characteristics rather thoroughly, but fails to mention that the second filter must have linear *phase* characteristics. Recall that a triangular wave (which has a lower peak to average than a sine wave) has the same harmonic content as the square wave we went to all the trouble to produce; you might even decide to use a maximally linear phase characteristic in the filter despite its lack of steep skirts.

I haven't tried it, but I think there would be more in-band distortion if anyone tried to use two-stage clipping with a third filter between the two filter stages. The reason for this is that the input to the second filter contains in-band distortion products created by the first clipper.

Mr. Moxon went through a lot of detail explaining why anything not essential should not be allowed to enter the clipper stage. This brings to mind an interesting possibility. Most speech information is contained in three ranges: 300-750 Hz, 1250-1750 Hz and 2250-2750 Hz (Technical Correspondance, *QST*, December, 1960). While the original article claims 10-dB improvement, I believe this to be for the receiving case as there is not that much speech power in the ranges 750-1250 Hz and 1750-2250 Hz.

With rf clipping it might be advantageous to build a three-band audio filter as the system is already rather complex and the filter system would not increase the complexity that much more. However, this must be tried as the results would be hard to analyze by analytical reasoning, as are most electronic systems involving the speech waveform. Anyone trying this should remember, however, that there should be provisions for switching the filters out if slow-scan tv operation is contemplated.

Larry Tessari, WA8ASD
Taylor, Michigan

In regard to the first paragraph, there seems to be some confusion between clipping level which is fixed by, for example, the bias on a diode, and the amount of clipping which is the number of dB by which speech peaks exceed this bias level.

It is important for the clipping level to be clearly defined for the reason given on page 33 of my article. Any uncertainty about the peak level means that the drive to the final must be reduced by an amount equal to the uncertainty, since otherwise you cannot be sure of not overdriving the stage. On the other hand, my fig. 1 shows that the amount of clipping can vary between 15 and 25 dB for a little over 1-dB change in average signal level, so there is no need to keep this amount particularly constant.

Nonlinearity is, of course, inseparable from clipping, but the experimental evidence is that any potentially harmful distortion is submerged under the wanted signal. Distortion is intermodulation not harmonic, and as those who have measured it say it is at least 10 dB down, it should amount to no more than a slight increase of background noise. The rounding of corners of the speech envelope is likely to be a function of the filter characteristic rather than the clipper. I have not found it necessary to use a compressor in front of the clipper but this would no doubt be an advantage to operators less used to speaking at a constant level.

It is an interesting question, however, as to what proportion of the statistical variations normally attributed to speech waveforms are inherent in the nature of speech and how much to inflections, emphasis, etc., occurring slowly enough to be taken care of by a compressor. This must obviously depend a lot on the individual.

Mr. Tessari raises an interesting point about the phase characteristics. I imagine the most serious consequence of a non-

-linear phase characteristic would be to delay high and low frequencies by different amounts, leading to amplitude variations at the output of the filter when both are present simultaneously. This could cause a system setup on i-f tones to go "over the top" occasionally on speech. I have not noticed this in practice but will have a more careful look for it.

It had not occurred to me to use a third filter between the two clipping circuits, and I would certainly agree that it would not be a good idea.

The 3-range idea is quite an old one, but my impression is that any restriction of bandwidth below that of an ordinary ssb filter produces a result which is not easy to listen to. This can be checked with a band-stop filter such as is sometimes used for removing CW interference. Rf clipping owes part of its effectiveness to boosting low-energy signals (if they occur in isolation) and this must presumably tend to fill in the 750-1250 Hz and 1750-2250 Hz gaps. I would agree, however, that it is not really possible to be analytical, and there are still plenty of unknowns in this field.

Leslie A. Moxon, G6XN

Dear HR:

I found the article by G6XN on the performance of rf speech clippers in the November, 1972, issue of *ham radio* to be quite informative and interesting. On page 33 the author refers to the question of acceptable passband ripple being halved by a two-filter system. I would like to point out that, based upon laboratory measurements, the passband ripple is actually *reduced* in relation to the amount of clipping, since it fills the valleys by nature of its basic process.

Typical current production filters, such as the Collins, etc., exhibit passband ripple in the area of a maximum 1.5 dB. More typically, in many that I have tested, they measure less than 1 dB.

Therefore, in rf clipping, with the conventional two-filter system, using well

matched filters for shape and impedance, no system degradation will be audible from the use of standard filters. This is confirmed by my own use of such a system for some time.

Marv Gonsior, W6VFR
Fullerton, California

rf speech clipping

Dear HR:

I read with great interest the paper on rf speech clipping by G6XN in the November, 1972, issue of *ham radio*. It is the best article I have read on the subject, and is a most informative and timely work.

I note that Mr. Moxon, on page 32, calls the theory behind pre-emphasis before speech clipping "obscure." On the contrary, I feel that it is quite straightforward as it applies to audio-frequency clipping.

One disadvantage of audio clipping, as compared to rf clipping, is that it generates in-band distortion products. These occur at odd-numbered multiples of the frequency of the clipped tone. For example, clipping a 100-Hz tone generates distortion products at 300, 500 and 700 Hz, etc.

In audio clipping, distortion products at 2500 Hz and higher are removed by a steep-skirted low-pass filter following the clipping stage. However, the distortion products of the lower frequencies are retained in the audio signal. These products are generated by the clipping of a tone below about 800 Hz. By minimizing the power in speech tones below 800 Hz, you can minimize the power of the in-band distortion products.

Unfortunately, however, much of the power density in normal speech is concentrated below 500 Hz, the most damaging region. In addition, these tones contribute little to communications intelligence. Therefore, they are best removed or attenuated before audio clipping.

Author OH2CD very effectively uses pre-emphasis in the clipper described in the February, 1972, issue of *ham radio*. In fact, he uses 12-dB per octave roll-off below 1400 Hz, and 18-dB per octave roll-off below 300 Hz.

The argument concerning distortion products does not apply to rf clipping, but pre-emphasis may nonetheless be useful since energy in speech tones below 500 Hz contributes little to communications intelligence while consuming considerable amounts of transmitter power.

Tom Ashley, WB4SIJ
Lexington, Kentucky

technical education

Dear HR:

I read with interest "A Second Look" in the January, 1973, issue of *ham radio*. Your observations on the trend in technical education are, in my opinion, accurate and timely. The collegiate level engineering studies have indeed reached a degree of sophistication that renders the graduate incapable of performing at the job site. These institutions, in striving for academic excellence, have failed to establish priorities relative to the actual industrial needs.

The real need in our field today is, as you stated, a "gut" understanding of electronics rather than mathematical sophistication. An alternative that you did not mention (and one that could perhaps contribute to a future article) is the practical and applied curricula offered by the many career training institutes around the country. These schools stick to the "gut" material and supply a large portion of the qualified technical personnel now being used. An excellent source of information is the National Association of Trade and Technical Schools, 2021 L Street, NW, Washington, D.C.; William A. Goddard, Executive Director.

E. R. Massengill, President
Tennessee Institute of Electronics
Knoxville, Tennessee

The Hams at Heath/Schlumberger* have a counter offer:

If you want test gear for the shack with famous Heath quality and performance at low mail order prices, but don't have time to build a kit, try us.

We're Heath/Schlumberger Scientific Instruments, a division of the Heath Company... the kit people. If you hold a ticket, you've probably heard of the Hams at Heath.

But you've probably never heard of us. We deal primarily with industry, r&d labs and colleges and universities. And we don't make kits; we don't even make ham gear. What we do make is some of the finest test and design gear on the market... all factory assembled and tested... all specification-guaranteed for one full year... all sold at low mail order prices.

Our new SM-110C Frequency Counter pictured above is a good example. It provides 600 MHz range, 15 mV input sensitivity, 7 digit LED readout and total computer or manual remote control capability for all



functions. And it's only \$795*. We also have a 200 MHz counter (our SM-110A) for just \$495*... an 80 MHz model (SM-105A) for only \$295*... and a scaler for \$365* that will extend the range of your present counter to 600 MHz.

We've got other goodies for your shack too: VOMs, DVMs, scopes, generators, power supplies... textbooks on basic and advanced electronics, digital techniques and computer logic... a complete line of plug-in digital and analog function circuit cards... all designed and manufactured in our own facilities... but all with the famous Heath quality and value.

Use the coupon below to send for our free 1973 Electronic Instruments catalog now.

*The Hams at Heath/Schlumberger: Chas, W8IAI; Tom, W8JAN; Norm, W8EEF; Jerry, K8KHS; Bob, K9EQB/8; Bill, K7IRC/8; Mike, WB8CDU; Owen, K3S JL/8; Lee, WA8PHL.

FREE...

1973
Heath/
Schlumberger
Electronic
Instruments catalog —
send coupon now.



		HEATH Schlumberger
Heath/Schlumberger Scientific Instruments Dept. 531-451 Benton Harbor, Michigan 49022		
<input type="checkbox"/> Please send 1973 Electronic Instruments catalog.		
Name _____		
Address _____		
City _____ State _____ Zip _____		
Prices and specifications subject to change without notice.		
*Mail order prices; F.O.B. factory.		EK-360

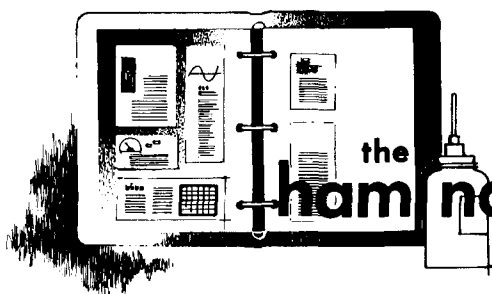

the ham notebook

sideband location

Frequently, you can find 30 to 50 upper-sideband stations in one day, operating within one kHz of 14349 or 21449 kHz, thus with the sideband extending over the band edge. This is contrary to FCC regulations, Section 97.63. In addition, Section 97.75 requires independent means for measuring the carrier frequencies, accurate enough to ensure keeping within the band. A bit of listening discloses the fact that many amateurs are uninformed, or are unwilling to comply.

Fig. 1 is an approximation of the situation in the Collins 32S-3 exciter. The carrier is off to one side so that it is suppressed 30 dB because of that, and another 20 dB or so in the balanced modulator. Using only the instruction manual information, not supported by measurements, you will note that the 2100-Hz filter width, 6 dB down, actually extends more than 2100 Hz above the carrier frequency because of the position of the carrier down on the side of the filter curve. At 30 dB down, the voice extends 2700 Hz above the carrier frequency.

In the Swan 500, fig. 2, even at 6 dB down, the modulation extends more than 2700 Hz higher in frequency. At 20 dB down, the voice extends to 3500 Hz above the carrier. At 60 dB down, the filter width is given as 4400 Hz, but the published curve is about 5 kHz wide there, of which about 1 kHz is below the carrier and some 4 kHz is above.

Filters may not all be as symmetrical as these. Some difference in the shape on one or the other side of the curve may be found.

Not many amateurs appreciate that the military and commercial frequency assignments are for the *midpoint* of the emission, *not* the suppressed carrier frequency which is widely used in amateur

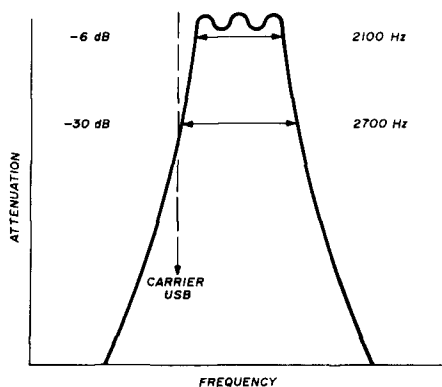

fig. 1. Bandwidths for Collins 32S-3 exciter in the USB mode.

radio. As a result, a MARS transmission in USB on a dial setting of 20998 kHz normally will extend appreciably into the bottom of the 15-meter band.

In order to keep the MARS stations on the right frequency, Navy-Marine Corps MARS has published fig. 3 in their instructions, DNC 8 (A). This is somewhat simplified, in that it does not stress the separation of the suppressed carrier from the modulation, nor any level of attenuation at the edges of the modulation. The illustration shows a presumed 3-kHz voice channel extending up from

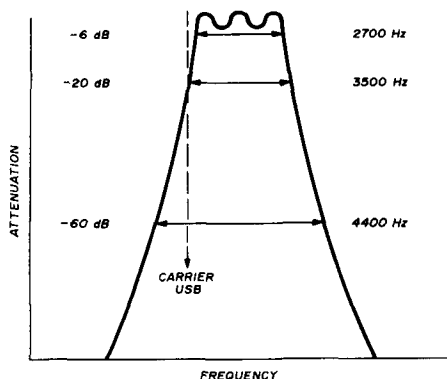

fig. 2. Bandwidths for Swan 500 transceiver in the USB mode.

the suppressed carrier. Therefore, you must set the exciter's suppressed carrier 1.5 kHz *below* the assigned frequency for USB transmission. As will be seen from fig. 2, some equipment would not keep within a 3 kHz channel unless you could accept perhaps only 12 dB attenuation outside of the channel; and the optimum detuning of the suppressed carrier would be slightly different.

From the illustrations it can be seen that fairly reasonable attenuation results when the Collins 32S-3 is operated in USB mode 3 kHz inside of the upper band edge, whereas the Swan 500 should stay inside by at least 4 kHz, and then only with suitable calibration equipment to ensure accuracy of the frequency measurement. A linear amplifier will raise the level of the emission and, therefore, of the filter curve, thus inviting greater interference to adjacent channels.

Minimum power is required by the Communication Act, Section 324, now written into the Amateur rules, Section 97.67 (b), as quoted in the October, 1972, issue of *QST*, page 108. Unnecessary

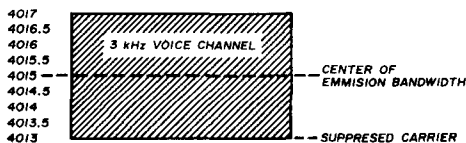

fig. 3. Example of emission published in Navy-Marine Corps MARS Communication Instructions, DNC 8 (A).

power may create considerable unnecessary splatter due to the filter skirts, equipment problems or nonlinearity in the several stages following the ssb filter and on through the linear amplifier. In addition, there may be off-frequency emissions greater than those indicated by the filter skirts demonstrated by the above tests. Furthermore, the transmitter can have a somewhat different filter performance than the receiver.

Bill Conklin, K6KA

swr bridge readings

When you can't obtain full-scale deflection on your swr bridge because of low power output or low antenna impedance, you may still determine the swr with fair accuracy by using the half-scale values listed in table 1.

table 1. Typical swr values when swr bridge is adjusted for half-scale deflection on forward power instead of full-scale deflection. This may be the case if power output is low or the output frequency is high.

half-scale swr reading	actual swr
1.1	1.2
1.2	1.3
1.3	1.5
1.4	1.7
1.5	2.0
1.75	3.0
2.0	3.5
2.5	4.0
3.0	Infinite

The swr bridge is calibrated in terms of half-scale forward meter deflection instead of full scale deflection. First, adjust the bridge for full-scale deflection in the forward direction. Produce a high swr reading (3:1 or 4:1) by detuning the antenna coupler or by any other convenient means. Now, reduce the forward reading to half scale and note the swr reading. Repeat the above steps until you have tabulated a complete set of swr readings as shown in table 1.

F.J. Bauer, W6FPO

new products

vhf fm scanner

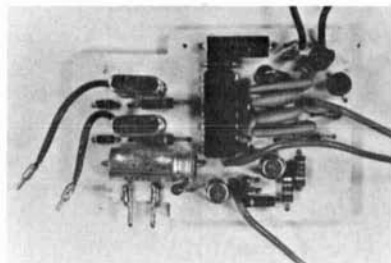

Topeka Engineering has just announced a two-channel frequency scanner for the Regency HR2 and HR2A transceivers, the *Scan 2*. The unit plugs into the HR2 with only three solder connections and one component change. The scanner unit mounts internally above the A, B and C crystal sockets. Scanning is accomplished by inserting the desired crystals into positions A and B. A and B channels will then be scanned when the switch is in position C so no change is required to the radio.

A unique search-back feature of the *Scan 2* allows the unit to scan a channel not in use every 5 seconds; this may be disabled or switched in or out. The scan rate is 20 times per second when no channel is in use. The *Scan 2* is available at \$19.95 including shipping from Topeka FM Communications and Electronics, 1313 East 18th Terrace, Topeka, Kansas 66607. For more information, use *check-off* on page 94.

midland enters amateur radio market



Midland Electronics Company, a leader in communications equipment for over a decade, has entered the amateur radio field. Leading off Midland's amateur radio offerings is a 15-watt, 12-channel, 2-meter fm mobile transceiver. This is a compact unit, 2-1/4" high by 6-3/8" wide by 8-7/8" deep, weighing only 4-1/2 pounds. It provides 15 watts rf output (1 watt in the low-power position) and contains a multiple fet front end receiver with high-Q helical resonator filters and ceramic filters. The model 13-500 operates on 12 volts dc and is supplied with push-to-talk microphone, mobile-mounting bracket and crystals for 16/76, 34/94 and 94/94. Suggested retail price is \$249.95. Additional crystals covering the full 2-meter range are available from Midland.

Midland's 10-watt, 12-channel 220 fm unit brings a much-wanted, low-cost mobile transceiver to this growing amateur band. The model 13-509 transmits at 10 watts or 1 watt rf output, and has the same compact size and light weight of the two-meter mobile equipment. Features and equipment are similar throughout and 223.00 simplex crystals are supplied. Suggested retail price is \$219.95.

All of these new Midland amateur radio transceivers are described fully in a colorful new catalog. For a free copy of this catalog or information on Midland's amateur radio dealer franchise program, contact the Midland Sales Manager, Midland Electronics Company, Box 19032, Kansas City, Missouri 64141, telephone (816) 474-5080, or use *check-off* on page 94.

electronic keyer



A super low-power electronic keyer using complementary MOS (C-MOS) integrated circuits has been announced by Curtis Electro Devices. For QRP in the field or the full gallon at home, the EK-420 C-MOS Deluxe Keyer offers effortless, self-completing dots, dashes and spaces, dot memory, iambic operation, built-in side-tone and 4-inch speaker, built-in power supply and a reed relay for grid-block keying or solid-state rigs. It operates on 115 Vac or +4.5 to +14 Vdc.

Because of C-MOS circuitry, the EK-420 consumes only $\frac{1}{2}$ mW during stand-by. When keying, power consumption rises to 180 mW. This allows extended operation on an inexpensive snap-in 9-volt transistor battery. A rear-panel accessory socket allows instant connection of a soon-to-be-announced four program, 2048-bit (200-character) memory unit.

Front-panel controls include sidetone volume and pitch, weight and speed, tune, self-test, and ac-battery selector switch. All eight ICs, three transistors and the reed relay plug in to allow easy field service.

Housed in a heavy gauge case, the EK-420 is priced at \$139.95 complete. For more information contact Curtis Electro Devices, Inc., Box 4090, Mountain View, California 94040, or use *check-off* on page 94.

mobile antenna mount

The new Larsen Electronics mobile antenna mount, described in the June, 1973, issue of *ham radio*, is designed for the usual 3/4-inch hole, *not* a 3-inch hole. The mount is available from Larsen Electronics, Inc., Box 1686, Vancouver, Washington 98663.

THE \$39.⁹⁵ 2 METER FM TRANSMITTER

It's here . . . a single channel, crystal controlled solid state FM transmitter with built-in speech processing. A complete circuit board assembly (1 $\frac{1}{2}$ oz., 3.75 cu. in.) NOT a Kit that doesn't have it all together. Includes miniature crystal microphone, complete technical data. Fully tested. Just connect battery, antenna and microphone, and you're in the 2 meter world.

TYPICAL PERFORMANCE SPECIFICATIONS

Transmitter output into 50 ohms:	200 MW typical @ 8.1v
Frequency Stability:	$\pm 0.0025\%$ (-35°C to $+55^{\circ}\text{C}$), nom. freq. ref.
Current Drain:	70 ma. @ 8.1v
FM Noise:	45 dB below 3.3 KHz, deviation @ 1000 Hz.
Modulation:	Phase Modulation
Audio Response:	± 3 dB of 6dB/octave pre-emphasis over 300-3000 Hz.
Deviation:	± 5 KHz (adjustable)

Available for limited time only. Fill out the order form below NOW and mail with check or money order payable to ComData Division, International Signal & Control Corp.

1-4 units \$39.95 5 or more \$34.90

INCLUDING MICROPHONE

146.94 or 146.34 or 146.16

Extra Crystals \$2.95 each, available only with order for transmitter. List Frequencies Below:

.....
(Pennsylvania residents, please add 6% sales tax.)

Name

Address

City State Zip

International Signal & Control Corp.
3050 Hempland Road
Lancaster, Pa. 17601 Tel. (717) 299-3671

SPACE SAVER TOWERS & MASTS

CZ series towers, cranks up, installs without guy wires. New lacing design creates greater strength. Mini and Magna rotating masts . . . high strength galvanized tubing, self supporting crank-up.

For complete details and prices please check your local dealer or write
Certified Welders L.A. City License #634

TRISTAO TOWER CO.
P.O. Box 115, Hanford, California 93230



MODEL "A" Frequency Counter

10 Hz to 80 MHz (± 1 Hz) Direct Count
Guaranteed (1 Hz to over 100 MHz typical)
Read Out: 5 digit LED + Over Range
Sensitivity: 100 millivolts
Either 120 VAC or 12 VDC power required
Small Size: 2.34" x 5.68" x 8.18"
Price: \$250.00 FOB Vista, Ca.

MODEL "AS" Frequency Counter

EXACTLY AS ABOVE PLUS AN INTERNAL SCALER (± 10 Hz) 70 MHz to over 250 MHz DIRECT COUNT
ONE BNC CONNECTOR FOR BOTH RANGES
INTRODUCTORY PRICE UNTIL 1 SEPT. 1973:
\$325.00 FOB Vista, Ca.

(CA residents add sales tax)



ELECTRONICS

P.O. BOX 1672
VISTA, CA. 92083
714-726-1313

WE PAY **HIGHEST**
PRICES FOR ELECTRON
TUBES AND SEMICONDUCTORS

H & L ASSOCIATES

ELIZABETHPORT INDUSTRIAL PARK
ELIZABETH, NEW JERSEY 07206
(201) 351-4200

TTL OPERATING RULES _____ \$ 0.50

MINITRON 5-VOLT 16-PIN DIP READOUT

7-SEGMENT W/RH DECIMAL _____ \$ 3.25
 ± 1 W/RH DECIMAL _____ \$ 3.25

DIGITAL CLOCK SEMI-KIT _____ \$ 32

15 IC'S & 4 MINITRONS (ONLY) + RED FILTER & INSTR.

DIGITAL CLOCK INSTRUCTIONS ONLY _____ \$ 1.50

QUAD OP AMP LM 3900 _____ \$ 1.15

REGULATOR 5-VOLT 1-AMP μ A 7805 _____ \$ 2.50

Arizona Semiconductor

PO BOX 112 GOODYEAR, ARIZONA 85338

DIGITAL: THEORY, DESIGN,
CONSTRUCTION

**LOGIC
NEWSLETTER** ©

SAMPLE COPY \$ 1.00
LOGIC NEWSLETTER
POB 252
WALDWICK, N.J. 07463

QRM QRM QRM

WHY FIGHT QRM?

Win the battle against CW QRM with the new DE-101 using advanced integrated circuit design. Connect it between your receiver and high impedance earphones for a guaranteed superior CW reception. Operate your receiver the same way as before except now you discriminate against QRM. No adjustments, the DE-101 is factory tuned and complete with built in ac supply. One year warranty. 4" x 2 1/2" x 6" \$29.95 plus \$2.00 shipping.

ATTENTION EXPERIMENTERS

Raise your printed circuits and breadboards with inexpensive 1/4 inch long plain metal spacers for a #4 screw. 30 for \$1.00 postpaid.

Ala. residents add 5% sales tax.

DYNAMIC ELECTRONICS INC.

BOX 1131 DECATUR, AL. 35601

QRM

QRM

QRM



QRM QRM QRM

CW or RTTY, whichever way you go,
**HAL HAS TOP QUALITY
 YOU CAN AFFORD!**



TOP QUALITY RTTY... WITH THE HAL MAINLINE ST-6 TU. Only 7 HAL circuit boards (drilled G10 glass) for all features, plug-in IC sockets, and custom Thordarson transformer for both supplies, 115/230 V, 50-60 Hz. Kit without cabinet, only \$135.00; screened, punched cabinet with pre-drilled connector rails, \$35.00; boards and complete manual, \$19.50; wired and tested units, only \$280.00 (with AK-1, \$320.00).*



TOP QUALITY... WITH THE HAL 1550 ELECTRONIC KEYSER. Designed for easy operation; perfectly timed CW with optional automatic ID for sending call letters, great for DX and RTTY; TTL circuitry, transistor switching for grid block, cathode keying. Handsome rugged crackle cabinet with brushed aluminum panel. With ID, only \$90.00; without ID, \$65.00.*

OTHER HAL PRODUCTS INCLUDE:

- | | |
|--|-----------|
| ID-1 Repeater Identifier (wired circuit board) . . . | \$ 75.00* |
| ID-1 (completely assembled in 1 1/2" rack cabinet) | \$115.00* |
| HAL ARRL FM Transmitter Kit | \$ 50.00* |
| W3FFG SSTV Converter Kit | \$ 55.00* |
| Mainline ST-5 TU Kit | \$ 50.00* |
| Mainline AK-1 AFSK Kit | \$ 27.50* |



TOP QUALITY... WITH THE HAL MKB-1 MORSE KEYBOARD.

As easy as typing a letter—you get automatic CW with variable speed and weight, internal audio oscillator with volume and tone controls, internal speaker, and audio output jack. Smooth operation; completely solid-state, TTL circuitry using G10 glass boards, regulated power supplies, and high voltage transistor switch. Optional automatic ID available. Assembled MKB-1, \$275.00. In kit form, \$175.00.*



NEW FROM HAL—TOP QUALITY RVD-1002 RTTY VIDEO DISPLAY UNIT.

Revolutionary approach to amateur RTTY... provides visual display of received RTTY signal from any TU, at four speeds (60, 66, 75, and 100 WPM), using a TV receiver modified for video monitoring. Panasonic solid-state TV receiver/monitor, or monitor only, available. RVD-1002, \$525.00; Panasonic TV receiver/monitor, \$160.00; monitor only, \$140.00.*

TOP QUALITY... WITH THE HAL RKB-1 TTY KEYBOARD.

Gives you typewriter-easy operation with automatic letter/number shift at four speeds (60, 66, 75, and 100 WPM). Use with RVD-1002 video display system, or insert in loop of any teleprinter, for fast and easy RTTY. Completely solid state, TTL circuitry using G10 glass boards, regulated power supplies, and transistor loop switch. RKB-1 assembled, only \$275.00.*



HAL provides a complete line of components, semi-conductors, and IC's to fill practically any construction need. Send 24¢ to cover postage for catalog with info and photos on all HAL products available.

*Above prices do not include shipping costs. Please add 75¢ on parts orders, \$2.00 on larger kits. Shipping via UPS whenever possible; therefore, street address required.

HAL COMMUNICATIONS CORP., Box 365 H, Urbana, Illinois 61801

ENJOY CW!

USE A MATRIC KEYSER & PADDLE

- SELF COMPLETING • BATTERY OPERATED
- RELAY OUTPUT



MODEL 10
 CIRCUIT BOARD KIT (LESS CASE) \$12.95
 KIT (LESS BATT).....\$21.90
 WIRED (LESS BATT)\$26.50
 SIDETONE KIT \$4.95 • WIRED \$6.95

PADDLE

MODEL 11



- ★ ADJUSTABLE TRAVEL
- ★ NON-SKID WEIGHTED BASE
- ★ FULLY ASSEMBLED

ONLY \$9.95

SEE YOUR DEALER

OR ORDER DIRECT. PRICES F.O.B. FRANKLIN, PA.



RD 1, PONE LANE
 BOX 185A
 FRANKLIN, PA. 16323

PHONE: AREA CODE (814) 432-3647

TECO ELECTRONICS

ALL ITEMS CHECKED AND OPERATING, SHIPPED FOB GARLAND, TEXAS. 10 DAY MONEY BACK GUARANTEE IF NOT SATISFIED (RETURNED PRE-PAID)

MIIDA 60 COUNTER AS IN CQ AND QST MAG. 60 MHZ SOLID STATE 50 MV SENSITIVITY \$299.00
 URM-25D SIGNAL GENERATOR, 10 kHz-52MHz WITH CALIBRATED OUTPUT, BUILT-IN XTAL CALIBRATOR, AM MOD. SMALL SIZE \$125.00
 HP-524B COUNTER DC-10MHz NEON READOUT \$95.00
 HP-524C COUNTER DC-10MHz NIXIE READOUT \$275.00
 HP-524D COUNTER DC-10MHz NEON READOUT \$195.00
 HP-525A OR B PLUG-IN 10MHz TO 220 MHz \$50.00
 HP-540B SAME AS ABOVE BUT TO 12.4 GHz \$125.00
 HP-233A AUDIO GENERATOR 50Hz-500kHz \$65.00
 HP-400HR AC VTVM TO 4 MHz 1MV-300V \$65.00
 HP-430C/477B POWER METER AND MOUNT \$85.00
 LAMDA 12V/11A PS 0.02% REG. NEW UNITS \$65.00
 TEK 535 SCOPE DC-11 DELAYED SWEEP \$295.00
 FLUKE 801 DC DVM TO 500 VOLTS 0.05% ACC \$40.00
 FLUKE 803 SAME AS ABOVE BUT AC-DC \$85.00
 GERTSCH FM-7 & DM-3 FREQUENCY METER \$795.00
 POLARAD TSA/STU-1 SPECT. ANAL. 10MHz-1GHz \$225.00
 SORENSEN 500BB PS 0-500V/300MA 0.5% REG \$45.00
 HP-650AR AUDIO GENERATOR 10Hz-10MHz \$75.00
 HP-330BR DISTORTION ANALYZER \$225.00
 USM-50C OSCILLOSCOPE: 3 INCH, 5 HZ TO 20 MHz scope with calibrated vertical and sweep amps. These are the last and the best models of the USM-50 series manufactured. Built-in calibrator for the vertical and a marker gen. for the sweep generator. Sweep from 0.2 microseconds to 37,000 microseconds plus sweep delay. Shipping wt. 65 lbs. IN EXCELLENT WORKING CONDITION \$69.95

OVER 15,000 ITEMS IN STOCK, PRICED TO SELL
 WRITE TODAY WITH YOUR REQUIREMENTS OR CALL

TECO ELECTRONICS

P.O. BOX 1050-B, GARLAND, TEXAS 75040, 214-276-4931
 STORE HOURS 11 AM TO 7 PM CLOSED SUN. & MON.

A COMPLETELY PORTABLE FREQUENCY COUNTER WITH . . .

- * 10 HZ to 65 MHz range
- * Full six digit readout (L.E.D.)
- * Sensitive front end (LESS THAN 10 MV.)
- * Only \$199

FEATURES

- High capacity rechargeable Ni Cd batteries
- Crystal controlled time base (can be field calibrated)
- Convenient 3-position range select switch allows:
 1. Readout always in MHz.
 2. Eight digit resolution by range selection
 3. Direct reading pre-scalar operation to 999.999 MHz.
- "Battery save" switch for spot checks
- Less than 5 watts power consumption (5 volts @ 0.9 AMPS)
- Dimension 6" x 3.5" x 2.3"
- TTL input for use with pre scalar
- Can be operated on internal or external power, with trickle charge and full charge positions
- Sample control lets operator determine how often the readout is updated. Can "hold" present count without being updated



Mail orders directly to:
 Great American Miniatures,
 Inc.
 P. O. Box 10990
 Midwest City, Okla. 73110

Model C-65 Freq. counter \$199.00
 Battery charger 8.00
 Battery charger & eliminator 18.00

for the EXPERIMENTER!

INTERNATIONAL EX CRYSTAL & EX KITS

OSCILLATOR • RF MIXER • RF AMPLIFIER • POWER AMPLIFIER



1. MXX-1 TRANSISTOR RF MIXER

A single tuned circuit intended for signal conversion in the 3 to 170 MHz range. Harmonics of the OX oscillator are used for injection in the 60 to 170 MHz range. Lo Kit 3 to 20 MHz, Hi Kit 20 to 170 MHz (Specify when ordering).....\$3.50



2. SAX-1 TRANSISTOR RF AMP

A small signal amplifier to drive MXX-1 mixer. Single tuned input and link output. Lo Kit 3 to 20 MHz, Hi Kit 20 to 170 MHz (Specify when ordering).....\$3.50



3. PAX-1 TRANSISTOR RF POWER AMP

A single tuned output amplifier designed to follow the OX oscillator. Outputs up to 200 mw, depending on the frequency and voltage. Amplifier can be amplitude modulated. Frequency 3,000 to 30,000 KHz.....\$3.75

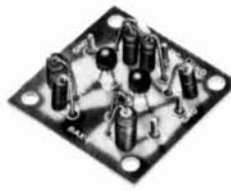

4. BAX-1 BROADBAND AMP

General purpose unit which may be used as a tuned or untuned amplifier in RF and audio applications 20 Hz to 150 MHz. Provides 6 to 30 db gain. Ideal for SWL. Experimenter or Amateur\$3.75



5. OX OSCILLATOR

Crystal controlled transistor type. Lo Kit 3,000 to 19,999 KHz, Hi Kit 20,000 to 60,000 KHz. (Specify when ordering).....\$2.95



6. TYPE EX CRYSTAL

Available from 3,000 to 60,000 KHz. Supplied only in HC 6/U holder. Calibration is $\pm .02\%$ when operated in International OX circuit or its equivalent. (Specify frequency)\$3.95

for the COMMERCIAL user...

INTERNATIONAL PRECISION RADIO CRYSTALS

International Crystals are available from 70 KHz to 160 MHz in a wide variety of holders. Crystals for use in military equipment can be supplied to meet specifications MIL-C-3098E.

CRYSTAL TYPES: (GP) for "General Purpose" applications
(CS) for "Commercial Standard"
(HA) for "High Accuracy" close temperature tolerance requirements.



write for CATALOG



CRYSTAL MFG. CO., INC.
10 NO. LEE • OKLA. CITY, OKLA. 73102

Go all the way into the REPEATER

There's nothing half-way about the new Hy-Gain REPEATER LINE.

Designed for the man who demands professional standards in 2 meter mobile equipment, the REPEATER LINE is the 2 meter HAM's dream come true. It's got everything you need for top performance...toughness, efficiency and the muscle to gain access to distant repeaters with ease. Reaches more stations, fixed or mobile, direct, without a repeater.

The right antennas for the new FM transceivers ...or any 2 meter mobile rig.

Rugged, high riding mobiles. Ready to go where you go, take what you dish out...and deliver every bit of performance your rig is capable of.

260 Commercial duty 1/4 wave, claw mounted roof top whip. Precision tunable to any discrete frequency 108 thru 470 MHz. 17-7 ph stainless steel whip.

261 Same as above. Furnished complete with 18' of coax and connector.

262 Rugged, magnetic mount whip. 108 thru 470 MHz. Great for temporary or semi-permanent no-hold installation.

Complete with coax and connector. Base matching coil for 52 ohm match. 17-7 ph stainless steel whip.

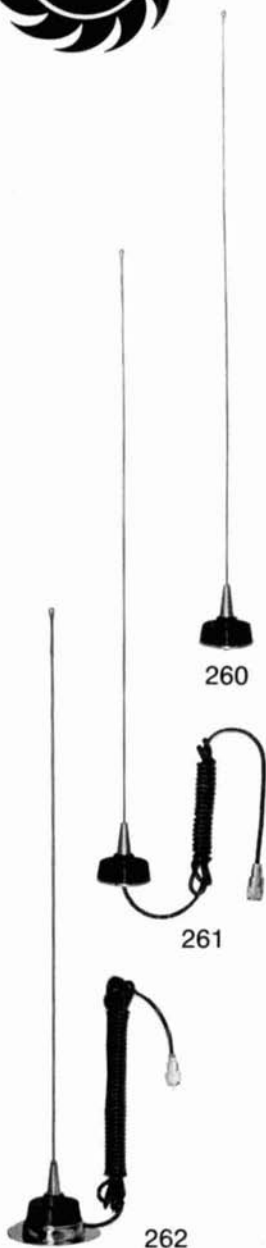

2 meter mobile! with

LINE from **HY-GAIN**

263 Special no-hole trunk lip mount. 3 db gain. 130 thru 174 MHz. 5/8 wave. Complete with 16' coax. Operates at DC ground. Base matching coil for 52 ohm match. 17-7 ph stainless steel whip.

264 High efficiency, vertically polarized omnidirectional roof top whip. 3 db gain. Perfect 52 ohm match provided by base matching coil with DC ground. Coax and connector furnished.

265 Special magnetic mount. 3 db gain. Performance equal to permanent mounts. Holds at 90 mph plus. 12' of coax and connector. Base matching coil for 52 ohm match. 17-7 ph stainless steel whip. DC ground.

269 Rugged, durable, continuously loaded flexible VHF antenna for portables and walkie talkies. Completely insulated with special vinyl coating. Bends at all angles without breaking or cracking finish. Cannot be accidentally shorted out. Furnished with 5/16-32 base. Fits Motorola HT; Johnson; RCA Personalphone; Federal Sign & Signal; and certain KAAR, Aerotron, Comco and Repco units.

**Top performance for 2 meter mobiles
THE REPEATER LINE
from**

HY-GAIN ELECTRONICS CORPORATION

BOX 5407 - WH LINCOLN, NEBRASKA 68505

WRITE FOR DETAILS

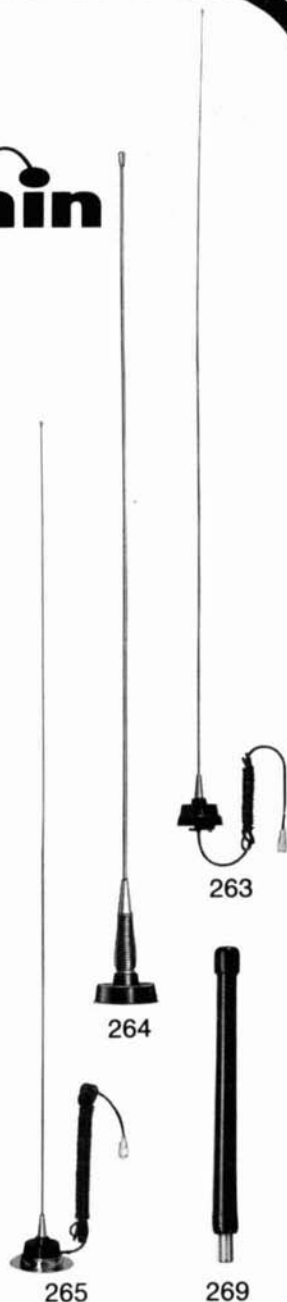

NEW RX-144C RECEIVER KIT

*For Repeaters or Those
Who Need The Best*

\$69.95

WITH 10.7 CRYSTAL FILTER



- Low cross modulation front end
- 10.7 MHz crystal filter
- Sensitive noise squelch
- COR output for control
- 2 watts audio output
- Less than .2 μ V sensitivity
- Measures 4 x 6 x 1 inches

ALSO AVAILABLE

TX-144 Transmitter Kit \$29.95 — RX-144 Receiver Kit \$59.95 — PA-144 Amplifier Kit \$29.95

Add \$1.00 shipping per kit ordered. New York Residents add sales tax.

We are now in our new location, please note the new address.



VHF ENGINEERING

— DIV. OF BROWNIAN ELECT. CORP. —

320 WATER ST. POB 1921 BINGHAMTON, N.Y. 13902 607-723-9574

STOP

You're about to pass up bargains on Northwest Florida's newest and fastest growing dealer.

REGENCY HR-2MS	\$319.00
REGENCY HR-212	\$259.00
REGENCY HR-220	\$239.00
HYGAIN TH6DXX	\$179.95
HYGAIN 204BA	\$149.95
GALAXY GT-550A	\$595.00
HALLICRAFTERS SR400A	\$995.00
HALLICRAFTERS FPM300	\$595.00
ICOM IC-20	\$299.00
ICOM IC-21	\$399.00
ICOM IC-22	\$279.00
GLADDING 25	\$249.95
GENAVE GTX-10	\$199.95
GENAVE GTX-200	\$259.95
STANDARD 146A	\$289.00

Drop me a line for those unadvertised extras

GOLDSTEIN'S

P. O. BOX 3561
PENSACOLA, FLA. 32506
Phone 904-455-2533

signal/one CX7A



Special Purchase Sale \$1895*

Last chance to buy
latest series CX7A.

90 day warranty by dealer.

complete parts inventory available

*5% discount for no-trade in sale
Phone/write Don Payne, K4ID
for a King-Size trade on your gear

PAYNE RADIO

BOX 525
SPRINGFIELD, TENN. 37172
Days (615) 384-5573 Nites (615) 384-5643

Join us...

ON SEPTEMBER 22nd!

EVANS will be celebrating its 40th Anniversary—and in conjunction with that celebration will be holding an Open House and a Trade Show. This will enable you to view our expanded EVANS facilities and to see the newest products being offered by the companies which we represent.

Mark September 22, 1973 on your calendar and reserve that day for the EVANS 40th Anniversary Open House and Trade Show.

DOORPRIZES

EXHIBITS

SURPRISES

REFRESHMENTS



Hours 9-4

Box 893 Concord N H 03301
(Routes 3A, 89, 93 - Bow Junction)
603 224 9961

<p>NATIONAL MOS DYNAMIC shift registers 10-5 MM502 dual 50 bit 1.25 MM506 dual 100 bit 1.75 MM5006 dual 100 bit 1.50 MM5013 1024 bit 2.00</p> <p>MM5016 512 bit 1.50</p> <p>STATIC shift registers MM504 dual 16 bit 1.50 MM505 dual 32 bit 1.75</p> <p>MM550 dual differential analog switch 2.50</p> <p>KEYBOARD General Telephone Ten push buttons (0-9) touch-tone, encoding, programming devices. Easy for panel mounting.</p> <p>\$5.95 Size: 3x2x1 1/2</p> <p>MY-50 red emitting 10-40ma @ 2V .39 MY5020 red LED .45 MY-10B Visible red 5-70ma @ 2V .45</p>	<p>CT5005 CALCULATOR ON A CHIP This chip has a full four function memory. Memory is controlled by four keys, M (adds entry to memory), -M (subtracts entry from memory), CM (clear memory—without clearing rest of registers), RM (read memory or use as entry).</p> <p>12 DIGIT DISPLAY AND CALC. FIXED DECIMAL AT 0,1,2,3, 4, OR 5 LEADING ZERO SUPPRESSION SEVEN SEGMENT MULTIPLEXED OUTPUT TRUE CREDIT SIGN DISPLAY SINGLE 28 PIN CHIP Chip and data—\$14.95 Data only—1.00 (refundable)</p> <p>1101/2501 256 BITx1 MOS memory \$2.56</p> <p>MANI Popular 7 segment diffused LED. Dual in line 14 pin capable of displaying all digits and nine distinct letters.</p> <p>\$4.00 each</p>	<p>7400 TTL DIP</p> <table border="1"> <tr><td>7400</td><td>.....</td><td>\$.35</td></tr> <tr><td>7401</td><td>.....</td><td>.35</td></tr> <tr><td>7402</td><td>.....</td><td>.35</td></tr> <tr><td>7403</td><td>.....</td><td>.35</td></tr> <tr><td>7404</td><td>.....</td><td>.35</td></tr> <tr><td>7405</td><td>.....</td><td>.35</td></tr> <tr><td>7411</td><td>.....</td><td>1.75</td></tr> <tr><td>7010</td><td>.....</td><td>.35</td></tr> <tr><td>74L10</td><td>.....</td><td>.50</td></tr> <tr><td>7420</td><td>.....</td><td>.35</td></tr> <tr><td>7430</td><td>.....</td><td>.35</td></tr> <tr><td>7440</td><td>.....</td><td>.35</td></tr> <tr><td>7441</td><td>.....</td><td>1.60</td></tr> <tr><td>7442</td><td>.....</td><td>1.30</td></tr> <tr><td>7443</td><td>.....</td><td>1.75</td></tr> <tr><td>7444</td><td>.....</td><td>1.30</td></tr> <tr><td>7448</td><td>.....</td><td>1.15</td></tr> <tr><td>7450</td><td>.....</td><td>.35</td></tr> <tr><td>7451</td><td>.....</td><td>.35</td></tr> <tr><td>7453</td><td>.....</td><td>.35</td></tr> <tr><td>7454</td><td>.....</td><td>.35</td></tr> <tr><td>7455</td><td>.....</td><td>.35</td></tr> <tr><td>7472</td><td>.....</td><td>.50</td></tr> <tr><td>7473</td><td>.....</td><td>.65</td></tr> <tr><td>7474</td><td>.....</td><td>.65</td></tr> <tr><td>7476</td><td>.....</td><td>.70</td></tr> <tr><td>7480</td><td>.....</td><td>.65</td></tr> <tr><td>7481</td><td>.....</td><td>1.30</td></tr> <tr><td>7486</td><td>.....</td><td>.80</td></tr> <tr><td>7491</td><td>.....</td><td>1.15</td></tr> <tr><td>7492</td><td>.....</td><td>1.15</td></tr> <tr><td>7493</td><td>.....</td><td>1.15</td></tr> <tr><td>7495</td><td>.....</td><td>1.25</td></tr> <tr><td>74107</td><td>.....</td><td>.70</td></tr> <tr><td>74154</td><td>.....</td><td>2.50</td></tr> <tr><td>74192</td><td>.....</td><td>2.50</td></tr> <tr><td>74193</td><td>.....</td><td>1.50</td></tr> <tr><td>74195</td><td>.....</td><td>1.10</td></tr> </table>	7400	\$.35	740135	740235	740335	740435	740535	7411	1.75	701035	74L1050	742035	743035	744035	7441	1.60	7442	1.30	7443	1.75	7444	1.30	7448	1.15	745035	745135	745335	745435	745535	747250	747365	747465	747670	748065	7481	1.30	748680	7491	1.15	7492	1.15	7493	1.15	7495	1.25	7410770	74154	2.50	74192	2.50	74193	1.50	74195	1.10
7400	\$.35																																																																																																																		
740135																																																																																																																		
740235																																																																																																																		
740335																																																																																																																		
740435																																																																																																																		
740535																																																																																																																		
7411	1.75																																																																																																																		
701035																																																																																																																		
74L1050																																																																																																																		
742035																																																																																																																		
743035																																																																																																																		
744035																																																																																																																		
7441	1.60																																																																																																																		
7442	1.30																																																																																																																		
7443	1.75																																																																																																																		
7444	1.30																																																																																																																		
7448	1.15																																																																																																																		
745035																																																																																																																		
745135																																																																																																																		
745335																																																																																																																		
745435																																																																																																																		
745535																																																																																																																		
747250																																																																																																																		
747365																																																																																																																		
747465																																																																																																																		
747670																																																																																																																		
748065																																																																																																																		
7481	1.30																																																																																																																		
748680																																																																																																																		
7491	1.15																																																																																																																		
7492	1.15																																																																																																																		
7493	1.15																																																																																																																		
7495	1.25																																																																																																																		
7410770																																																																																																																		
74154	2.50																																																																																																																		
74192	2.50																																																																																																																		
74193	1.50																																																																																																																		
74195	1.10																																																																																																																		
<p>TRIAC 2N6344 600V DA TO-220 \$1.00</p> <p>LED FL 100 special !!!! each \$1.30 (Ham Radio Specials!) ten or more—20.00</p> <p>each \$1.30 (Ham Radio Specials!) ten or more—20.00</p> <p>all IC's are new and fully tested, leads are plated with gold or solder. Orders for \$5 or more will be shipped prepaid. Add 35¢ for smaller orders. California residents add sales tax. IC orders are shipped with 24 hrs. COD's may be phoned in 310. minimum money back guarantee. P.O. Box 3 Carmichael California 95608</p> <p>BABYLON ELECTRONICS (916) 966-2111</p>	<p>LINEARS</p> <table border="1"> <tr><td>LM100</td><td>.....</td><td>\$1.00</td></tr> <tr><td>LM309H</td><td>.....</td><td>.75</td></tr> <tr><td>LM309K</td><td>.....</td><td>2.00</td></tr> <tr><td>NE5556</td><td>.....</td><td>1.00</td></tr> <tr><td>NE560</td><td>.....</td><td>3.25</td></tr> <tr><td>741(MINI DIP)</td><td>.....</td><td>.45</td></tr> <tr><td>747</td><td>.....</td><td>1.10</td></tr> <tr><td>709</td><td>.....</td><td>.45</td></tr> <tr><td>710</td><td>.....</td><td>.40</td></tr> <tr><td>711</td><td>.....</td><td>.40</td></tr> <tr><td>723</td><td>.....</td><td>1.00</td></tr> <tr><td>LM380(audio amp)</td><td>.....</td><td>1.75</td></tr> </table> <p>CMOS</p> <table border="1"> <tr><td>CD4001</td><td>.....</td><td>\$.75</td></tr> <tr><td>CD4002</td><td>.....</td><td>.75</td></tr> <tr><td>74C00</td><td>.....</td><td>.75</td></tr> <tr><td>CD4012</td><td>.....</td><td>.75</td></tr> <tr><td>CD4023</td><td>.....</td><td>.75</td></tr> </table>	LM100	\$1.00	LM309H75	LM309K	2.00	NE5556	1.00	NE560	3.25	741(MINI DIP)45	747	1.10	70945	71040	71140	723	1.00	LM380(audio amp)	1.75	CD4001	\$.75	CD400275	74C0075	CD401275	CD402375																																																																
LM100	\$1.00																																																																																																																		
LM309H75																																																																																																																		
LM309K	2.00																																																																																																																		
NE5556	1.00																																																																																																																		
NE560	3.25																																																																																																																		
741(MINI DIP)45																																																																																																																		
747	1.10																																																																																																																		
70945																																																																																																																		
71040																																																																																																																		
71140																																																																																																																		
723	1.00																																																																																																																		
LM380(audio amp)	1.75																																																																																																																		
CD4001	\$.75																																																																																																																		
CD400275																																																																																																																		
74C0075																																																																																																																		
CD401275																																																																																																																		
CD402375																																																																																																																		

400% MORE AVERAGE SSB POWER OUTPUT

USE A **MAGNUM SIX** THE QUALITY R F SPEECH PROCESSOR



Collins-Haath	\$130.95
Drake T4X/T4XB	\$154.95
Drake TR4	\$159.95
Yaesu FT101	\$139.95
Kenwood TS69, TS-611	\$139.95

Add 5% Tax in Washington

- 4 TIMES THE SSB POWER ON ALL BANDS
- ADDED PUNCH FOR PILE-UPS
- EXCELLENT VOICE QUALITY
- SPLATTER FREE, NARROW BAND OUTPUT SIGNAL
- SOLID STATE DESIGN
- PUT YOUR TRANSMITTER TO WORK FOR THE FIRST TIME IN ITS LIFE. POWER UP WITH A MAGNUM SIX FOR MORE ADDED POWER PER \$ THAN ANY OTHER METHOD!

Send for FREE Brochure
Communication Technology Group
31218 Pacific Highway South
Federal Way, Washington 98002

 A Division of Birc Systems Inc.

G&G RADIO ELECTRONICS COMPANY

45-47 Warren St. (Dept. H-A) New York, N. Y. 10007 212-267-4605



HANDMIKE Rugged, heavy-duty carbon hand mike with press-to-talk switch. Equipped with 4-ft cord & phone plug. **NEW, Boxed, Each \$1.88; 2 for \$3.25**



HEADSET Low impedance. With large chamois ear cushions. 4-ft cord & plug. Reg. \$12.50. Our **SPECIAL Price \$2.95**. Less ear cushion \$1.95. High impedance adaptor for above 69¢

SCR-274-N, ARC-5 COMMAND SET HQ!

Freq. Range	Type Complete with Tubes	Exc. Used	Like New	BRAND NEW
190-550 Kc	BC-453	\$16.95	\$23.50	—
6-9.1 Mc	BC-455	\$16.95	—	—
1.5-3 Mc	R-25	—	—	\$21.50
TRANSMITTERS Complete with tubes and crystal				
4-5.3 Mc	BC-457	\$8.95	—	\$11.95
5.3-7 Mc	BC-458	\$8.95	—	\$11.95

BRAND NEW BC-645 TRANSCEIVER

EASILY CONVERTED FOR 420MC OPERATION

This equipment originally cost over \$1000. You get all in original factory carton.



Dependable Two Way Communication more than 15 miles.

- FREQUENCY RANGE: About 435 to 500 Megacycles.
- TRANSMITTER has 4 tubes: WE-316A, 2-6F6, 7F7.
- RECEIVER has 11 tubes: 2-955, 4-7H7, 2-7E6, 3-7F7.
- RECEIVER I. F.: 40 Megacycles.
- SIZE: 10 1/2" x 13 1/2" x 4 1/2".

\$26.95

Makes wonderful mobile or fixed rig for 420 to 500 Mc. Easily converted for phone or CW operation

"SPECIAL PACKAGE OFFER"

24 PAGE Catalog, crammed with Gov't Surplus Electronic Gear — the Biggest Bargain Buys in America!

SEND 25¢ FOR YOUR COPY

TERMS: F.O.B. NYC. 25% deposit with order, balance COD or remittance in full. MINIMUM ORDER \$5.00. Subject to prior sale and price change



Radio Amateurs Reference Library of Maps and Atlas

WORLD PREFIX MAP — Full color, 40" x 28", shows prefixes on each country . . . DX zones, time zones, cities, cross referenced tables — postpaid **\$1.25**

RADIO AMATEURS GREAT CIRCLE CHART OF THE WORLD — from the center of the United States! Full color, 30" x 25", listing Great Circle Bearings in degrees for six major U.S. cities; Boston, Washington, D. C., Miami, Seattle, San Francisco & Los Angeles. — postpaid **\$1.25**

RADIO AMATEURS MAP OF NORTH AMERICA! Full color, 30" x 25" — includes Central America and the Caribbean to the equator, showing call areas, zone boundaries, prefixes and time zones, FCC frequency chart, plus informative information on each of the 50 United States and other Countries — postpaid **\$1.25**

WORLD ATLAS — Only atlas compiled for radio amateurs. Packed with world-wide information — includes 11 maps, in 4 colors with zone boundaries and country prefixes on each map. Also includes a polar projection map of the world plus a map of the Antarctica — a complete set of maps of the world. 20 pages. size 8 1/4" x 12" — postpaid **\$2.50**

Complete reference library of maps — set of 4 as listed above — postpaid **\$3.75**

See your favorite dealer or order direct.

WRITE FOR FREE BROCHURE!

RADIO AMATEUR



callbook INC.

Dept. E 925 Sherwood Drive
Lake Bluff, Ill. 60044

NEW - 440 MHZ PREAMPS

\$54.95

POSTPAID
432PA-1



Two stage preamps use KMC Bipolar and Mosfet Transistors. 20db gain, 20 MHz bandwidth. These are high quality preamps suitable for the most demanding applications. AC models have die cast case, others have metal enclosure.

432PA 3.5db NF 12VDC	\$29.95
432PA-1 3.5db NF 117VAC	\$54.95
432PC 1.5 to 2.0db NF 12VDC	\$69.95
432PC-1 1.5 to 2.0db NF 117VAC	\$94.95

Write for our new catalog.

JANEL LABORATORIES

P. O. BOX 112
SUCCASUNNA, N. J. 07876
201-584-6521

GROTH-Type

COUNTS & DISPLAYS YOUR TURNS



- 99.99 Turns
- One Hole Panel Mount
- Handy Logging Area
- Spinner Handle Available

PRICES POST PAID
TC 2 — \$7.00
TC 3 — \$7.50
Spinner (S) — \$1.00
Add \$0.75 for Air or UPS

Case: 2x4"; shaft 1/4"x3"
Model TC2: Skirt 2 1/2"; Knob 1 1/2"
Model TC3: Skirt 3"; Knob 2 1/2"

R. H. BAUMAN SALES

P.O. Box 122, Itasca, Ill. 60143

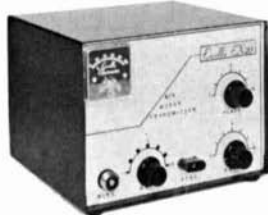

8MC. XTALS-8333-9000.
Silk Screened Panel.
18 Watts Output.

SIX METER TRANSMITTER

- for
- MOBILE
 - FIXED STATION
 - EMERGENCY
 - AVIATION

TUBE COMPLIMENT
6U8 Oscillator Multiplier
12AX7 Speech Amplifier
2E26 Final Amplifier
6BQ5 Modulator

Price **49.95**

Net to Amateurs
Complete with Tubes
Power Supply \$9.95



EXCELTRONICS RESEARCH LABS
MANUFACTURERS OF ELECTRONIC DEVICES
224-15 Linden Blvd. Cambria Heights, N. Y. 11411



YAESU

YOUR ASSURANCE OF PERFORMANCE & QUALITY

SP101-P \$59.00
SP101 19.00

FV101 \$99.00
160M THROUGH 10M

FT101 \$649.00
TRANSCVR 260W PEP

FL2100 \$329.00
80M THROUGH 10M
1200W PEP



The SP101-P Landliner provides phone patch operation as well as speaker. Front panel: Patch switch, meter, TX and RX gain controls. Rear apron: Receiver 4 ohm output, receiver 600 ohm output, monitor null switch, balance control, line jack, transmitter high Z jack.

The FV-101 permits split frequency operation and control from either the FT-101 or FTDX401.

The FT-101 exciter covers 160, 80, 40, 20, 15, (CB), and 10 meters and comes complete with microphone cable and plug, fused DC power cable and plug. AC cable with plugs and all necessary plugs are furnished. AC and DC supplies are internal.

The FL-2100 linear amplifier needs only 3 wire cable and coax cable. Connectors are furnished.

FTDX401 \$599.00
TRANSCVR 560W PEP

FV401 \$99.00
EXTERNAL VFO
80M THROUGH 10M

FL2000B \$399.00
LINEAR AMP
1200W PEP

FRDX400 \$299.00
RECEIVER
160M THROUGH 10M



The FTdx401 features high power, super sensitivity and sharp selectivity. The FT-dx401 includes: AC power supply, noise blanker, 100 KC and 25 KC calibrators. VOX break-in, phone patch terminal, cooling fan. Covers 3.5 through 10 MHz plus WWV. 560 watts PEP. All that is required to get on the air is a microphone and speaker.

The FV-401 permits split frequency operation for the DX chaser or net operator. Covers 80 through 10 meters.

FL 2000 B 1200 watts PEP, 1000 watts CW, 600 watts AM. Drive power required 100 watts. Has two cooling fans and uses two 572 B tubes.

FRdx400 includes 2 mechanical filters plus "T" notch rejection tuning, and clarifier for easy zero set for SSB. Crystal control 1st mixer and tunable 1st I.F. provides stable operation and high spurious rejection. 100 KC and 25 KC calibrators. VFO can be used in transceive operation in conjunction with F series transmitter.

FLdx400 operates SSB, (USB LSB selectable), AM, CW and FSK. Circuitry can be built in for RTTY operation. 240 watts PEP. VOX, PTT, and break-in CW.

FL 2000B grounded grid linear uses a pair of 572 B tubes. Plate meter VSWR monitor, 2 fans, built-in power supply, 80 through 10 meters, 1200 watts PEP with distortion product in excess of 30 DB down.

FLDX400 \$399.00
EXCITER
80M THROUGH 10M

FL2000B \$399.00
LINEAR AMP
1200W PEP

SP401-P \$59.00
SP401 19.00
SPEAKER/PATCH

FP-2
AC POWER SUPPLY



FT2FB \$239.00
144-148MHz
10W HIGH 1W LOW

FT2-AUTO \$379.00
144-148MHz



YC355-D \$289.00
DIGITAL COUNTER BUILT IN PRESCALER



Complete with
A.C. Power Cord 6 Ft.
D.C. Power Cord 6 Ft.
Signal Test Lead with
BNC Connector 3 Ft.

FP-2 AC power supply specifications: Output - 13.5 volts, 2 amps. AC input - 100/117/220/234 volts. Speaker - 5" x 3 1/2". Portable or home base operation can be achieved with the addition of the optional FP-2 power pack. This AC power pack provides regulated DC power for the transceiver and charging voltage for optional leak proof rechargeable colloidal type batteries. In addition, a high fidelity elliptical style speaker is built into the pack.

The FT-2FB opens the door to noise free broadcast quality 2 meter operation, and thanks to the repeater stations throughout the country, the 2 meter band is no longer restricted to line of sight. General coverage 144 to 148 MHz, 12 channels (3 supplied). Push to talk. Receiver .3 amps, transmit 1.7 amps, power source 13.5 volts ± 10%. Dimensions 6-3/8" w. x 2-1/2" h. x 10" d., weight 4 lbs. Comes with dynamic microphone, connector plug, DC cord, fuse and mobile mount.

The FT-2 auto is a compact base or mobile VHF/FM transceiver, covering 146 to 148 MHz, featuring electronic scanning up to 8 stations between 146-148 MHz with priority channel sampling while locked on another channel. Adjustable tone burst push-button lock on for repeater actuation. The FT-2 auto is self-contained. Two power cables are supplied with the transceiver, including all mounting hardware, cables, connectors, and accessories required for both mobile and base installation, as well as dynamic push to talk microphone. Operates from various AC voltages or 13.5 DC. Dimensions 8-3/4" w. x 4-1/4" h. x 11-5/8" d. Weight 9 lbs.

SPECIFICATIONS

YC-355D		YC-355D		YC-355D	
Frequency range	5Hz to 35MHz (50Hz to 200MHz)	MAX Input Voltage	60V p.p. less than 10 sec (5V p.p.)	Weight	220(W) X 80(H) X 70(D) (8 3/4 W X 3 3/4 H 10 1/2 inches)
Accuracy	± time base stability - 1 count	Input Impedance	HIGH 1 M ohm Low 50 ohms	Tube	Display tube
Display	5 Digit	Input Capacity	Less than 20pF	Semiconductors	Silicon diode
Sampling time	1 multi sec. or 1 sec	Time base Frequency	1 MHz Crystal controlled		Silicon transistor
Display time	0.1 sec - 2 sec	Stability	0.0025% at 0° - 40° C		FET
Frequency Unit	KHz MHz	Power Requirements	100/110/117/200/220/234V 50/60Hz 18V A		IC
Display	Display tube		12-14.5V 1A		
Input Voltage	20mV - 20V p (0.15V - 5V p.p.)				

PRICES SUBJECT TO CHANGE WITHOUT NOTICE

FACTORY SERVICE IS AVAILABLE WHERE WARRANTY HAS EXPIRED MODIFICATION KIT MK-160 (160M) \$16.00 WITH XTAL. PLUS LABOR. MODERNIZATION KIT MIR-1 FOR OLDER MODEL FT101 \$40.00 PLUS LABOR. BROCHURES WITH SPECIFICATIONS ARE AVAILABLE AT YOUR DEALERS LISTED BELOW:

HENRY RADIO STORES/213 477 6701
Los Angeles, Anaheim, CAI., Butler, Mo.
HAM RADIO OUTLET/415-342 5757
Burlingame, Cal.
RACOM ELECTRONICS/206 255 6656
Renton, Wash.

WILSON ELECTRONICS/702 457 3596
Pittman, Nev.
ED JUDGE ELECTRONICS/817 926 5221
Fort Worth, Tex.
ANATEUR ELECTRONICS SUPPLY/414 442 4200
Milwaukee, Wis. Cleveland, Ohio

FRECK RADIO & SUPPLY/704 254 9651
Asheville, N.C.
HARRISON RADIO/516 293 7990
Farmingdale, L.I. Valley Stream, L.I. New York City, N.Y.



YAESU MUSEN USA INC.

7625 E. ROSECRANS AVE. UNIT 29 PARAMOUNT, CAL. 90723

TWX 910 346-7624
TEL 213-633-4007

URC-11 WALKY TALKY

243 MC 2 way radio, hand held, measures 3 x 4 inches. Used for survival in downed aircraft. May be converted for other frequencies.

URC-11 \$15 each or 3 for \$40.00



7 SEGMENT LED



Hobby craft due to being factory rejects. Most have a segment or decimal inoperative. Still a great "buy" for the experimenter. What an unusual tie clip you can make with pocket battery . . . demo displays, etc. In many applications you don't need full 7 segments. \$1.00 each or \$10 the dozen. 0.333 inches high character.

As above only this one is the giant display 13/16 inches hgt. of character. First time offered and as far as we know, offered no where else. This one is quite an attention getter. Also available in this giant display numeral "one" with "plus" and "minus" sign. Again, these are rejects. Giant display \$1.50 each 12 for \$15.00

GIANT 7 SEGMENT

As above only this one is the giant display 13/16 inches hgt. of character. First time offered and as far as we know, offered no where else. This one is quite an attention getter. Also available in this giant display numeral "one" with "plus" and "minus" sign. Again, these are rejects. Giant display \$1.50 each 12 for \$15.00

JOHN MESHNA JR. ELECTRONICS

GIANT LED 83¢

Price break at last on these giant LED with 1,000,000 hours of life. Measure full 1/4 by 1/4 inch. First time offered.

RED \$1.00
GREEN \$1.25

SUPER BRIGHT collimated RED with parabolic reflector, measures 3/16 diameter. A real hi-intensity red visible over 100 ft.

SUPER RED \$1.25
All above LED's 12 for the price of 10



CORE STACK

Late model memory stacks, unused

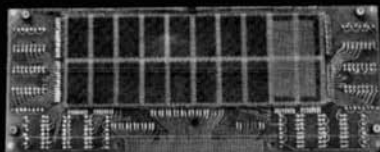

1Kx9	\$ 35.00
2Kx9	\$ 50.00
8K 4 bit Y-plane	\$ 40.00
16K 4 bit Y-plane	\$ 60.00
147K stack	\$100.00

Postage Extra on all items

P. O. Box 62 E. Lynn, Mass. 01904

VARIABLE FREQUENCY OSCILLATOR



New From Ten-Tec, for crystal controlled transmitters.

Solid-state — permeability tuned. Direct frequency read out Grid-block or VFO keying. 10-80 meters. Plugs into FT 243 crystal socket. 115 VAC. Finished in cream and vinyl wood tones.

From your dealer or direct. If ordered direct, add \$2 for shipping. Tennessee residents add sales tax.

PRICE \$69.00

TEN-TEC, INC.
SEVIERVILLE, TENNESSEE 37862

ON LINE SWR & POWER METERS



PRICE — \$29.95

FREQUENCY RANGE: 3 - 150 MHz
IMPEDANCE: 50 ohms
POWER: 0 - 1 Kw



PRICE — \$49.95

FREQUENCY RANGE: 3.5 - 150 MHz
IMPEDANCE: 50 or 75 ohms
POWER: 0 - 2 Kw

For further information and catalogs write, cable or call:

CARVILL INTERNATIONAL CORP.
P. O. Box 4039, Foster City, Ca., U.S.A. 94404
Cable "CARVILL" • Phone (415) 341-9959 • Telex 349334

GRAB HOLD Of ... the IC-22



22 channels of pure pleasure for only \$289

● TEN crystals . . . (now that *alone* is going to save you about \$40.00) . . . easy to hold noise canceling dynamic mike . . . a quick disconnect mobile mount . . . battery saving HI (10 watts)/Lo (1 watt) power option. ● Your IC-22 will have a receiver that just *won't quit* with a super hot mosfet front end, 5 helical resonators (you can forget about inter-mod), and a large speaker that will punch out plenty of audio for the car. ● You'll also be on frequency with trimmer caps on both trans. and rcv. on all 22 channels. . . . with a discriminator output jack in the back to let you get on and stay on freq. ● PLUS the '22' is one good lookin' compact rig that you will be proud to put in your car—(the XYL won't mind it either)—with soft green back lighting on the front panel and a light to silently let you know you are getting out . . . and a second light to let you know there is an incoming signal (even though you may have the volume down). ● There is much, much more to tell you about the IC-22, but suffice it to say, the IC-22, with all of its unique features and performance record at \$289.00, has got to be one of the best all-around values available on two meters today!

— SEE THE IC-22 AT YOUR LOCAL DEALER —

Distributed by:



ICOM

Dealer inquiries invited.

ICOM WEST
1251 - 170th St. N.E.
Bellevue, Wash. 98008
(206) 641-0554

ADIRONDACK
RADIO SUPPLY
185 West Main Street
Amsterdam, N.Y. 12010

ICOM EAST
Div ACS, Inc.
Box 331
Richardson, Tex. 75080
(214) 235-0479

ALPHA 77 by ETD

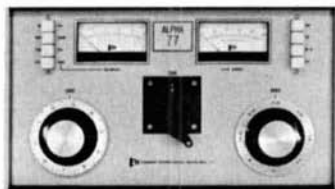

Featuring the new Giant from Eimac, the 8877, with 1500 watts of plate dissipation. 10 to 160 meters:

Warranty: One Year
Power Supply - Two Years

Phone/write DON PAYNE, K4ID for a brochure, and a King-Size trade on your gear.

Days (615) 384-5573
Nites (615) 384-5643

PAYNE RADIO
BOX 525
SPRINGFIELD, TENN. 37172

FREE Catalog

99¢ Crystals Hermetically Sealed 99¢
1.30000 8.25833 44.58500
6.69444 9.73750 44.91833
7.00000 12.60000 70.80000

99¢ Wire Buy 99¢

100' 22 ga. twisted pair
125' 20 ga. single cotton covered
coil cord extends to 5 1/2' 3 conn.
P. C. wire 200 pair 12" length multi-color

99¢ Relay Buy 99¢

6 poles D. T. 115 vac. 60 cps. h-sealed

99¢ Noise Filter 99¢

5 amps, 115 vac, 400 cy

99¢ Transistor 99¢

Some crimp for P. C. work

2N404	12/99	2N1308	7/99¢
2N976	4/99	2N1309	5/99¢
2N1304	10/99	2N1499A	2/99¢
2N1306	9/99	2N2219	2/99¢
2N1307	9/99	2N1748A	4/99¢

99¢ Diodes 99¢
1N1202 2/99¢

99¢ Capacitors 99¢

10 MFD 1000 vdc oil
45 MF x 45 MF, 300 dv electrolytics

Vidicon 7735A \$50.00
4CX250B \$17.00
4X150A \$11.00

All new — American made
Please add postage for above

IN-X-SALES

BOX 222 . MEDFORD, MASS. 02155

know this sign



To most people this is a symbol from Greek mythology. But to hundreds of thousands of active amateurs, Pegasus is the symbol of the Radio Amateur CALLBOOK the single most useful operating reference for active amateur stations. The U.S. Edition lists over 285,000 Calls, Names and Addresses in the 50 States and U.S. possessions while nearly 200,000 amateur stations in the rest of the World are listed in the DX edition.

Both editions contain much other invaluable data such as World Maps, Great Circle Maps, QSL Managers around the World, ARRL Countries list and Amateur Prefixes around the World, Time information, Postal Information and much, much more. You can't contest efficiently, you can't DX efficiently, you can't even operate efficiently without an up to date CALLBOOK.

To make the CALLBOOK even more valuable, three supplements are issued each year which bring your copy completely up to date every three months. These are available at a modest extra cost. Full details in every CALLBOOK.

Get your copies of the big new 1973 CALLBOOKS today.

US CALLBOOK (less service editions) Just \$8.95	DX CALLBOOK (less service editions) Just \$6.95
---	---

US CALLBOOK (with service editions) \$14.95	DX CALLBOOK (with service editions) \$11.45
---	---

Mail orders add 50¢ per CALLBOOK postage and handling.

See your favorite dealer or send today to:

WRITE FOR FREE BROCHURE **RADIO AMATEUR callbook INC.**
Dept. E 925 Sherwood Drive
Lake Bluff, Ill. 60044

The voice of



is heard around the world



Here's why Thunderbirds outperform all other tri-banders:



- * Thunderbird's "Hy-Q" traps provide separate traps for each band. "Hy-Q" traps are electronically tuned at the factory to perform better at any frequency in the band—either phone or CW. And you can tune the antenna, using charts supplied in the manual, to substantially outperform any other antennas made.
 - * Thunderbird's superior construction includes a new, cast aluminum, tilt-head universal boom-to-mast bracket that accommodates masts from 1 1/4" x 2 1/2". Allows easy tilting for installation, maintenance and tuning and provides mast feed-thru for beam stacking.
- Taper swaged, slotted tubing on all elements allows easy adjustment and readjustment. Taper swaged to permit larger diameter tubing where it counts! And less wind loading. Full circumference compression clamps are mechanically and electrically superior to self-tapping metal screws.
- * Thunderbird's exclusive Beta Match achieves balanced input, optimum matching on all 3 bands and provides DC ground to eliminate precipitation static.

- * 25 db front-to-back ratio.
- * SWR less than 1.5 to 1 on all bands.
- * 24-foot boom...none longer in the industry.
- * Extra heavy gauge, machine formed, element to boom brackets, with plastic sleeves used only for insulation. Bracket design allows full mechanical support.
- * Interlaced, optimum spaced elements for higher gain and better pattern control.
- * 3 active elements on 20 and 15 meters. 4 active elements on 10 meters.

New 6-Element Super Thunderbird
Model 389
Suggested retail price, **\$189.95**

Improved 3-Element Thunderbird
Model 388
Suggested retail price, **\$154.95**

Fabulous 3-Element Thunderbird, Jr.
Model 221
Suggested retail price, **\$109.95**

Popular 2-Element Thunderbird
Model 390
Suggested retail price, **\$99.95**

Buy one today at your favorite Hy-Gain distributor!

HY-GAIN ELECTRONICS CORPORATION

Dept. WH, 8601 Northeast Highway Six Lincoln, NE 68507 402/434-9151 Telex 48-6424

Contact your local distributor or:

KLM ELECTRONICS

"THE COMMUNICATIONS EQUIPMENT INNOVATORS"

1600 Decker • San Martin, California 95046

(408) 683-4240 or (408) 842-7349

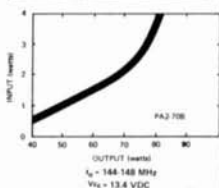

California residents add 5% — Add \$2.00 per unit for ppd U.S.A. Prices subject to change without notice.

Send for full amplifier and antenna catalogs.



ONLY

PA2-70B \$149⁹⁵

WORLD TIME-TELLER



GREAT for DX OP

A turn of knob and 2-color drum dial shows time your QTH and corresponding local time in all zones-also GMT. Fast-visual-great for sked making.

Map 2-color enamel on aluminum. Hand-crafted acrylic cabinet 9" long.

List: \$18.50 complete-postage prepaid USA. Kit: Complete \$14.75, or less cabinet and knobs (cab. dwgs. inc.) \$11.75

U-J Industries

6605 Shoal Creek Blvd.
Austin, Texas 78757

C F P ENTERPRISES

866 RIDGE ROAD
LUDLOWVILLE, NEW YORK 14862

Central Upstate New York's
Mail-Order Headquarters

Specializing in Two-Meter FM
and Quality Used Gear

Office & Salesroom Hours by Appointment Only
24-Hour Phone: 607-533-4297

Send SASE for Bi-Monthly Listing of
Used Equipment and Bargain Goodies

Trade-ins accepted on both new and used equipment. Cash deals get prepaid shipping in the Continental U.S.A. plus a 20% discount on the items on our regular listing!!!!



7 SEGMENT LED READOUTS. 0 THRU 9, PLUS SOME LETTERS. LEFT DECIMAL POINT. 1/4 X 3/8 CHARACTER SIZE. 20mA PER SEGMENT. COMMON ANODE FORMAT. SIMILAR TO MAN-1. FITS IN 14 PIN DIP SOCKET. STOCK #LRO-1090..... \$3.95

PLUS, MINUS, 1 DIGIT OVERFLOW. SAME MAN-1 SIZE. STOCK #LRO-1001.. \$3.95

6 AMP 200V MOLDED SILICON BRIDGE. .6" SQUARE - CENTER MOUNTING HOLE
STOCK #BRR-0622..... \$1.15

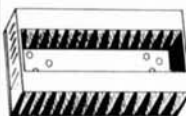
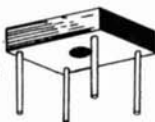

AIRFLOW HEAT SINK. PRE-PUNCHED FOR (6) TO-3 POWER TRANSISTORS. ACCORDIAN FOLD SANDWICH FOR HIGH HEAT TRANSFER EFFICIENCY. ALL ALUMINUM, GOLD ANODIZED. STOCK #H12063. \$1.25, 3 for \$3.25

ROCKER SWITCH. SPST, 10 AMP CONTACTS. EASY SNAP-IN MOUNTING. BLACK PLASTIC CASE WITH RED ROCKER. SPADE TERMINALS. STOCK #RSS-1210..... \$.35, 3 for \$1.00



TRI-tek, inc.

P.O. BOX 14206, DEPT HR
PHOENIX, ARIZONA 85063

NEW AND SURPLUS ELECTRONIC COMPONENTS FOR THE PRO AND SERIOUS AMATEUR. AN ORDER OR 8c STAMP PUTS YOU ON OUR MAILING LIST. MINIMUM ORDER \$3.00 U.S., \$15.00 FOREIGN. ALL ORDERS POSTPAID. PLEASE ADD INSURANCE

SAROC SAROC SAROC SAROC

9th annual fun convention

Best of Las Vegas — Best of Amateur Radio

January 3-6, 1974

SAROC Box 73 Boulder City, Nev. 89005

MINIATURE SUB-AUDIBLE TONE ENCODER

\$14.95
Wired-Tested



- Compatible with all sub-audible tone systems such as Private Line, Channel Guard, Quiet Channel, etc.
- Glass Epoxy PCB, silicon transistors, and tantalum electrolytics used throughout
- Any miniature dual coil contactless reed may be used (Motorola TLN6824A, TLN6709-B — Bramco RF-20)
- Powered by 12vdc @ 3ma
- Use on any tone frequency 67Hz to 250Hz
- Miniature in size 2.5 x .75 x 1.5" high
- Complete with Reed \$28.45 (Specify Freq.)
- Output 3v RMS sinewave, low distortion

Postpaid — Calif. residents add sales tax
COMMUNICATIONS SPECIALISTS

P. O. Box 153, Brea, CA 92621

KW107

SUPERMatch *is beautiful!*

- * E-Z Match Tuner
- * SWR Meter
- * Power Meter
- * Dummy Load
- * Antenna Switch
- * 350 watts PEP

\$134-95

Ppd in USA & Canada
 Moneyback Guarantee
 Clean up the unsightly
 tangle of wires around
 the shack and your wife
 will think it's beautiful



Send for FREE Literature



KW Electronics

55 Bridge St., Plattsburg, NY 12901
 In Canada: 214 Dolomite Dr.
 Downsview, Ont. M3J 2P8

NEW! IC KEYER

Only
 \$87.50
 PPD
 USA



- Self completing dots and dashes.
- Dot memory for easy keying.
- Precision feather-touch key built-in.
- Sidetone oscillator and speaker built-in.
- Relay output keys 300-V @ 100-ma.
- Keyed time base. Instant start.
- 5-50 wpm. Perfect dot-dash ratio.
- Send QSL or postcard for free brochure.

PALOMAR ENGINEERS

BOX 455, ESCONDIDO, CAL. 92025

1 mc - 100 kc

CRYSTAL CALIBRATOR



3 in. x
 3-1/2 in.

Model XC-20 • only \$17.50 ea, pp.

Use 1 mc Markers to Identify 100 kc Markers
 Outputs also Available at 500 and 200 kc
 Remote external switch (not supplied) can select any of the
 available outputs desired (no RF flows through switch leads).
 WWV zero beat adjustment - Factory set to exact frequency.
 Power requirement: 12 volts d.c. at 200 ma, intermittently.

10 Day Moneyback Guarantee - Send for Free Brochure
TRIONYX ELECTRONICS
 P.O. BOX 25796, LOS ANGELES, CALIF. 90025

END THE BATTLE OF THE CRYSTAL

Syntek, Inc. brings you the new SYNTEK I frequency synthesizer for two meters, with separate transmitting and receiving synthesized decks.

In addition, separate thumbwheel frequency selection switch decks are provided for transmitting and receiving.

Update your GE Progress Line, Motorola or any other rig with complete frequency flexibility. A full four MHz frequency range is provided in five kHz steps.

Introductory price \$199.95
 (plus postage)

State of Florida add 4% sales tax

Write For Specifications

SYNTEK, INC.

1304 EAST ATLANTIC BLVD.
 POMPANO BEACH, FL. 33060
 305-782-3465



Andy Electronics Co., Inc.

Department "B" 6431 Springer Houston, Texas 77017

All prices FOB Houston, Texas

AN/USM-50-OS 02 PRECISION OSCILLOSCOPE
 AC scope with a frequency response of 3MHz - 20MHz, and a risetime of .022us. Sensitivity is 24-25Mv./inch over the entire frequency range. This unit has a built in 1,000Hz. calibrator and superimposed marker dots at intervals of .2, 1, 5, 20, 100, 500, and 2,000us. for determining frequency. The CRT is 3". Also has a illuminated scale. 115V/60Hz. Ship. Wt. is 65 lbs. Excellent Condition (Checked)..... \$79.95
 Good Condition (Repairable)..... \$65.95

TS-392 AUDIO OSCILLATOR. Tunes from 20Hz. - 20KHz. Has a built in 60Hz. and 400Hz. calibrator meter. The output freq. has been calibrated to 2% of the freq. indicated on the main dial. 115V/60Hz. Ship Wt. 65 lbs. Excellent Condition (Checked)..... \$79.95
 Good Condition (Repairable)..... \$65.95

AN/USM-79 FR-4 PRECISION FREQUENCY METER
 Covers the frequency range of 100KHz. - 20MHz. 10 seven bands. Accuracy is .001% over the entire range. Frequency measurements and calibration, checking are made by means of a blinder light and earphones. This frequency meter has a 3" CRT for visual interpolation of the frequency being measured. Units are complete with interpolation book and operation manual. 115V/60Hz. Ship Wt. 105 lbs. Excellent Condition (Checked)..... \$79.95

BARRY

presents

CLEGG FM-27B



Total 146-148 MHz coverage without buying a crystal. Latest model 25w. out, fully synthesized.

\$479.95

Clegg FM-27B Regulated AC power supply
\$79.95

VIBROPLEX

Vibro Keyer Standard \$ 24.95
Deluxe \$ 32.95
Original Standard Vibroplex Bug \$ 29.95

INSTRUMENTS

RCA WO-91A 5" Scopes, 4.5 MHz \$ 95.00
Pan Adapter BC-1031A ± 100 kc unused with spare parts & book \$ 75.00

TEMPO

2 Meter Linear Amplifiers, 502, 5-12 watts input, 35-55 watts output \$105.00
802-B 1-2½ watts input, 80-90 watts output \$195.00

Large stock of inductors by B & W and Air Dux. Write or Order.

Barry has lots of James Millen and some National Radio parts in stock.

12 VOLT DC POWER SUPPLIES:

110 AC OUTPUT, all with full factory warranty
MODEL 102, is a 4 amp overload protected power supply that automatically resets itself when the overload is removed new, \$24.95
MODEL 104R, is a regulated power supply with the same electronic overload protection as the model 102. MODEL 104R new, \$34.95
MODEL 107M is a heavier duty supply with the same features as the Model 102 but puts out 6 amps, useful for Clegg 27 series, etc.
new, \$27.95

MARINE

Barry stocks Sonar, Pearce-Simpson, Andrea, SBE and Antenna Specialists VHF Transceivers, Antennas, Depth Finders and compasses by Andrea.

HALICRAFTERS

SR-150 Transceiver 10-80 meters AC or DC power supplies write
SR-160 Transceiver 80, 40, 20 meters write
PS-150-R DC power supply for SR-150 or SR-160 new, \$109.50
FPM-300 new, \$595.00

DX ENGINEERING

SPEECH COMPRESSORS

DIRECT PLUG-IN FOR COLLINS 32S \$79.50 ppd. U.S.A.
DIRECT PLUG-IN FOR KWM — 2 \$79.50 ppd. U.S.A.

Pay us a visit when you are in New York.
Thousands of unadvertised specials.

LITTLE LULU

Your chance to build a high quality deluxe AM, CW 6 meter transmitter. Can be converted to FM. See Aug. '63 QST, page 45 for complete details. 115 VAC and 12 VDC power. Parts and information available. Call or write for further details.

COLLINS

Just Arrived, 32S-3, 75S-3B Combo Write

ETO

ALPHA-77. The finest amplifier ever offered for amateur, commercial or military service. 3000 watts PEP continuous duty. Perfect companion to CX-7A Write

1 CX7A brand new, latest version, trade or cash.
RTTY Filters & CW Filters for CX7 & CX7A, write

STANDARD

SRC-146A 2 meter handheld transceiver \$289.00

TEN TEC

ARGONAUT MODEL 505, 5 band, SSB, 5 watt \$288.00
ARGONAUT 405 LINEAR AMP. 100w. PEP. 50w. out \$149.00
250 POWER SUPPLY, powers 505 & 405 \$ 49.00
315 RECEIVER 10-80 meters SSB, AM, CW \$229.00
CW FILTER FOR 315 \$ 14.95
AC4 SWR Bridge KR40 \$ 89.95
\$ 14.95 PM2A \$ 64.95
KR2 \$ 18.95

DYCOMM

DYCOMM BRICK, 2w in 35w out \$ 79.95
DYCOMM BLOCK, 10 in 50w out, new, \$ 99.95
demos, \$ 79.95

DRAKE

TR-22, in stock \$219.95
TR-72 2 meter FM transceiver, 23 channel, 1 & 10 watts, 13.8 VDC \$299.95
AC-10 AC Supply for TR-72 \$ 39.95
TR4/C new, \$599.95 W4 new, \$ 61.95
R4C Rec. \$499.95 T-4XC Trans. \$529.95
AC-4 Drake A.C. Power Supply \$ 99.95
MN-2000 — 2 KW PEP antenna tuner \$195.00

BARRY 512 Broadway NY, NY 10012
DEPT. H-8
212-WA-5-7000 **ELECTRONICS**

See Page 96 for more from Barry



HI SPIRE TOWERS

The Best Ham Tower
For 15 Years

- * Self-Supporting With A Tri-Bander (A)
- * 32' - 40' - 48' - 56'
- * 3 Mounting Bases
- * Heavily Galvanized

(A) Limited to JR TriBander,
unless guyed, on 56' towers.

\$79⁹⁵
32 FOOT
TOWER

**"THE BEST
TOWER
VALUE!"**



HI SPIRE CONSTRUCTION

Heavy steel "beaded" channel design for exceptional strength - much stronger than tubular of same weight. "X" bracing & bridge type construction for exceptional torsional stability. Positive riveted construction & heavy galvanizing makes it exceptionally durable for minimum maintenance. Tapering design provides "nesting" shipment at lower cost to you, as well as lighter sections as you go higher, making it easier to erect.

THREE BASES: Rigid concrete (recommended base is 3x3x3' in firm soil, 32/40' models, and 4' deep on 48/56' models. Hinged concrete base provides option of lay-over, providing you have suitable "gin-pole" and tackle facilities. And the **EARTH ANCHOR** base requires no concrete and holds well in firm (clay, etc.) soil and may be relocated later.

A custom drilled rotor plate is provided that accepts all CDE rotors (AR22R, TR44, HAM-M) and also the HY-GAIN 400 with slight enlargement of bolt holes. A friction thrust (lateral) bearing is included.

TOWERS WITH RIGID CONCRETE BASE

69C091.....32'	133 lbs.	\$ 79.95
69C092.....40'	175 lbs.	104.95
69C093.....48'	243 lbs.	144.95
69C137.....56'	308 lbs.	189.95

TOWERS WITH HINGED CONCRETE BASE

69C055.....32'	147 lbs.	\$ 89.95
69C056.....40'	189 lbs.	114.95
69C057.....48'	248 lbs.	154.95
69C138.....56'	313 lbs.	199.95

TOWERS WITH EARTH ANCHOR BASE

69C094.....32'	191 lbs.	\$119.95
69C095.....40'	233 lbs.	144.95
69C096.....48'	390 lbs.	239.95
69C139.....56'	455 lbs.	284.95

69C100, "T" wrench to drive anchors (8 lbs.) 9.95

Includes anchor base and anchors (anchor bases require no concrete). Earth anchors screw into the ground and hold well in firm soil. May be removed and relocated later.

"HI-SPIRE" towers shipped
truck collect from Indiana.

When you need "ham" gear &
accessories.... call H. I. !



**Hobby
Industry**

CALL: Tues./Sat.-Noon/5PM
At McMillan W0JJK
(712) 323-0142
WRITE: HOBBY INDUSTRY
Box 864
Council Bluffs, Iowa - 51501

flea market



■ **RATES** Commercial Ads 25¢ per word; non-commercial ads 10¢ per word payable in advance. No cash discounts or agency commissions allowed.

■ **COPY** No special layout or arrangements available. Material should be typewritten or clearly printed and must include full name and address. We reserve the right to reject unsuitable copy. **Ham Radio** can not check out each advertiser and thus cannot be held responsible for claims made. Liability for correctness of material limited to corrected ad in next available issue. Deadline is 15th of second preceding month.

■ **SEND MATERIAL TO:** Flea Market, Ham Radio, Greenville, N. H. 03048.

WE OFFER a complete repair service on all Collins receivers & transceivers listed. R-388-389-390-390A-391-392 — All S-line equipment including 515-1 651S-1 receivers. We stock and sell all parts above receivers. We also service all Collins Avionics equipment. Such as ARC-38-38A-58-73-94-102-114-115-116-131-134-618-T. We also buy the above avionics equipment, any quantity, any condition. We will send price list upon request. D & R Electronics, R. D. #1, Box 56, Milton, Pa. 17847. 1-717-742-4604.

SELL: FT101, 160M w/xtal, cw filter, fan, and mic., mint condx. D. Sachnoff, 9429 Ohio, Omaha, NE 68134.

STOLEN Drake TR-4, serial 31764. Removed from my car while I was a guest at Holiday Inn South in St. Louis (Sunset Hills, Mo.). Stolen night of May 26 last. Will pay reward. Lee J. Delworth, WB6RDW, 1125 N. Gardenia, Lompoc, CA 93436.

WANTED: tubes, transistors, equipment, what have you? Bernard Goldstein, W2MNP, Box 257, Canal Station, New York, N. Y. 10013.

GONSET Communicator III 2 meters \$100. Gonset 3063 2 meter power amplifier \$75, package \$150; Motorola P-33BAC with Ni-Cads 94/94 34/94 \$125; Heath HX-20 \$110, HR-20 \$75, HP-20 \$25, HP-10 \$35, Hustler 80-10 mobile antennas, mast mount \$35, package \$245; you pay shipping — W5PNY, 2506-A 35th St., Los Alamos, New Mexico 87544.

STOLEN WITH VW CAMPMOBILE, Drake ML-2, all xtals & mike. Ser. #10582. on-off SW broken. Notify W3MSN, (301) 894-3977 or Prince Georges, Md., County Police. Lawrence Briggs, W3MSN, 5108 Boulder Dr., Oxon Hill, Md. 20021.

HAMFESTERS 39th Hamfest and Picnic, Sunday, August 12, 1973, Santa Fe Park, 91st and Wolf Road, Willow Springs, Illinois, Southwest of Chicago. Exhibits for OM's and XYL's, Famous Swappers Row. Information contact John Raiger, K9DRS, 8919 Golfview, Orland Park, Illinois 60462. Tickets write Joseph Poradyla, WA9IWU, 5701 So. California Ave., Chicago, Ill. 60629.

"DON AND BOB" GUARANTEED BUYS. Discount prices plus full warranty. Triex MW50 tower 250.75; MW65 331.50; W51 386.00; FOB CAL. Ham-M 99.00; TR44 59.95; AR22R 31.95; Belden 8 wire rotor cable #8448 10¢/ft; Mosley CL36 149.00; CL33 124.00; TA33 114.00; MCQ3B 91.00; S402 143.00; MP33 90.00; Belden 8214 RG8 foam 17¢/ft; Motorola HEP 170 epoxy diode 2.5A/1000PIV 29¢ 25.00/100; KY65 Code IDER 5.95; Write specific needs new panel meters, stock; quote discontinued tubes; quote Clegg FM27B; Genave GTX2; Regency HR212; Midland 13500; Standard; Collins and CDE replacement parts; Hallicrafters FPM300A(\$95.00L) 499.00; hardbound technical magazines, many types from Petrochemical Library 3.00/yr write needs. 9 pin ceramic 6LQ6 socket 50¢; 6V/12V/24V/1.5A transformer 2.49; Collins 75A4 345.00; Kenwood T599 350.00. Shipping charges collect. Madison Electronics, 1508 McKinney, Houston, Texas 77002. 713/224-2668.

RESISTORS: Carbon composition brand new. All standard values stocked. 1/2W 10% 40/\$1.00; 1/4W 10% 30/\$1.00 — 10 resistors per value, please. Minimum order \$5.00. 15W RMS 1C Audio Amplifier — Panasonic. Frequency response 20Hz-100 kHz. 1/2% distortion. Price \$6.95 Postpaid. Pace Electronic Products, Box 161-H, Ontario Center, New York 14520.

QSLs. Second to none. Same day service. Samples 25¢. Ray, K7HLR, Box 331, Clearfield, Utah 84015.

THE RADIO CLUB OF TACOMA presents "Ham-fair — 73" August 18th and 19th at the Pierce County Fairgrounds near Graham (directly south of Puyallup on Meridian Avenue). Manufacturers' displays — technical seminars — games — contests — prizes — bunny hunts — swap shop — snack bar. Advance registration with Saturday evening dinner \$6.00. Registration without dinner or at door \$3.00. Tent, trailer, or camper space \$1.50 per night. Sunday Logger's Breakfast \$1.50. 3965 kHz and 146.76 MHz monitored. Contact Emil Koth, K7GPK, 13616 10th Avenue East, Tacoma, Washington 98445.

TONE-LOGIC Educational Systems for WWV, SSTV, RTTY. Eight 2 1/4" x 3" PCB's, plans, \$3. Hornung, Box 24614, San Jose, CA. 95154.

SIGNAL ONE OWNERS, expert and prompt service by ex-Signal/One engineer. Write or call for details. Larry Pace, K2IXP/7, 1071 W. Roller Coaster, Tucson, AZ. 85704 (602-888-5234).

FOR YOUR FUTURE ROBYN RADIOS send your order to, Two Way Radio Sales, 1501 Monroe Street, Bogalusa, La. 70427 or 202 Farrell Street, Picayune, Miss. 39466.

GOING QRP? British Joystick/Joymatch antenna systems available from stock. American plugs. Tunes any band 10 to 160. Used worldwide. \$59.00. Gilfer Associates, Box 239, Park Ridge, N.J. 07656.

SELL, TRADE HW-7 with 115VAC power supply \$75. R390/A receiver \$300, CV157 SSB converter \$300. K9HJU, 312-349-9002.

COMING SOON! Really effective, yet inexpensive speech processor. Speech Products, K. Teague, P. O. Box 65, Alma, Ark. 72921.

DISCOUNT SPECIALS! Clegg FM-27A @ \$378! Standard SR-C146 @ \$219.50, SR-C826M @ \$258! Genave, Mida, Mostley, Tri-Ex, Gladding, Sonar, Shakespear, many others. Also Marine and C.B. Arena Communications, Dept. C, 1169 N. Military Highway, Norfolk, Virginia 23502.

WANTED YAESU FT101 and FT2. W6BL, Box 1975, Beverly Hills, CA. 90213, Herb 213 653-2250 days.

MOBILE IGNITION SHIELDING provides more range with no noise. Available most engines in assembled or kit forms, plus many other suppression accessories. Free literature. Estes Engineering, 543-H West 184th, Gardena, California 90248.

"P.C.'S" I can supply boards for any construction article that includes the full size artwork. Many in stock. Write: D. L. McClaren, W8URX, 19721 Maplewood Avenue, Cleveland, Ohio 44135.

TELL YOUR FRIENDS about Ham Radio Magazine.



YAESU FT-101

now with 160 meters

SEE WILSON

for your Yaesu products

FTDX 401 Transceiver

FL2100 Linear Amplifier

FL2000B Linear Amplifier

Interested in trading Tempo One's
and other Yaesu equipment.

WILSON ELECTRONICS

BOX 794 HENDERSON, NEVADA, 89105
702-451-5791

SUPER CRYSTAL THE NEW DELUXE DIGITAL SYNTHESIZER!! FROM RP



MFA-22 DUAL VERSION

Also Available MFA-2 SINGLE VERSION

- Transmit and Receive Operation: All units have both Simplex and Repeater Modes
- Accurate Frequency Control: .0005% accuracy
- Stable Low Drift Outputs: 20 Hz per degree C typical
- Full 2 Meter Band Coverage: 144.00 to 147.99 MHz. in 10KC steps
- Fast Acting Circuit: 0.15 second typical settling time
- Low Impedance (50 ohm) Outputs: Allow long cable runs for mobiles
- Low Spurious Output Level: similar to crystal output

SEND FOR
FREE DETAILS

RP Electronics

Prices MFA-2 \$210.00 BOX 1201H
MFA-22 \$275.00 CHAMPAIGN, ILL.
Shipping \$3.00 extra 61820

CW/RTTY/ REPEATER IDENTIFIER

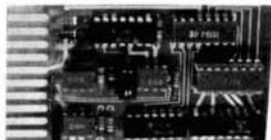

Uses 256 bit read-only-memory programmed for your call or message. NE555 timers for clock, tone generator and 5 minute timer. Apply 5 volts and COR and it outputs tone and PTT. Board \$8, Kit \$30, Tested \$35

OTHER BOARDS AVAILABLE:

Two Tone Decoder: \$25 Tested 16 Button Decoder:
\$95 Phase Locked Loop RTTY Converter: \$30 RY
Generator: \$17 2 Meter Preamp: \$13 8 Channel
Scanner: \$25 WRITE FOR FREE FLYER

SIGNAL SYSTEMS
2650 DURANGO DRIVE
COLORADO SPRINGS, CO. 80910
(303) 475-0380

LOW PRICES ON POPULAR COMPONENTS

IF FILTERS

- Monolithic crystal filters at 10.7 and 16.9 MHz
- Ceramic filters at 455 kHz

SEMICONDUCTORS

- VHF power transistors by CTC-Varian
- J and MOS FETS
- Linear ICs — AM/FM IF, Audio PA
- Bipolar — RF and AF popular types

INDUCTORS

- Molded chokes
- Coil forms — with adjustable cores

CAPACITORS

- Popular variable types

QUALITY COMPONENTS

- No seconds or surplus
- Name brands — fully guaranteed
- Spec sheets on request

GREAT PRICES

- Price breaks at low quantities
- Prices below large mail-order houses

WRITE FOR CATALOG 173

AMTECH

P. O. BOX 624, MARION, IOWA 52302
(319) 377-7927 or (319) 377-2638

FM Schematic Digest

A COLLECTION OF
MOTOROLA SCHEMATICS

Alignment, Crystal, and Technical Notes
covering 1947-1960

136 pages 11½" x 17" ppd \$6.50

S. Wolf

P. O. Box 535

Lexington, Massachusetts 02173

MORSAVERTERS READS HAND-SENT CW 10-80 wpm without adjustment and translates message into RTTY code including necessary CR, LF, LTRS, FIGS codes. Price reduced from \$560 to \$450 on wired and tested units. New kit of all parts, \$390. TMA-1 RTTY converter serves as RTTY-to-CW translator, Baudot loop to ASCII converter, or 64-letter buffer memory. Write for information. Petit Logic Systems, Box 51, Oak Harbor, Wa. 98277.

TOROIDS, iron "E" powder 80-10 meters. 500" — 8/\$1.00, 680" — 5/\$1.00. 940" — 4/\$1.00. 1.437" — 75¢ each or 3/\$2.00, 2.310" — \$1.50 or 3/\$4.00. Please include 50¢ postage, slightly more on large orders. Fred Barken, WA2BLE, 274 E. Mt. Pleasant Ave., Livingston, N. J. 07039.

THE CHICAGO AMATEUR RADIO CLUB announces its 4th annual Hamfest & Mini Auction on September 30th 1973. Time: 2 p.m. till last deal made, at St. Viator's School parking lot, 3606 N. Kedvale, N-W corner of Addison St. Swaps, prizes, refreshments. Donation at gate \$1.50 or for advance \$1.00 tickets contact: Don De Jong, W9KJL, 6158 W. Grand Ave., Chicago, Ill. 60639, Ph. 889-0329 or Kl. 5-3622; George Spockko, WA9JEZ, 5631 W. Irving Pk. Rd., Chicago, Ill. 60634.

CAPE COD'S fabulous Hyannis! N. E. ARRL Convention, September 29 & 30. Flea market, seminars, FM, SSTV, AMSAT, YL trips, 2 pools, golf, beaches, sailing. Early bird registration \$3. W1KCO, 572 Berkley Street, Taunton, MA. 02780.

YOUR KWM2 CAN WORK BETTER — You can do it, too. Write W0BNF, Box 105, Kearney, Nebr. 68847.

COMPLETE STATION: Ten-Tec Argonaut w/AC PS, \$260. 6M HE-45B w/VFO, \$25. ZM TR-108 w/VFO, \$50. Two'er, \$30. HP-10, \$35. Send SASE for full list. K4IQT, 2 Town & Country Trailer Park, Bristol, TN 37620; 1-615-968-3277.

WANT OLD RADIO SHOW TRANSCRIPTION discs. Any size or speed. Send details to, Larry Kiner, W7FIZ, 7554 132nd Ave. N.E., Kirkland, Wa. 98033.

WARREN HAMFEST, Largest family style Hamfest in East. Sunday, August 19th, at famous Yankee Lake Park. Giant Fleamarket, swimming, picnicing — All free. QSL W8VTD, Box 809, Warren, Ohio 44482.

CINCINNATI HAMFEST: The 36th Annual Hamfest will be held Sunday, September 16, 1973 at the ALL NEW Stricker's Grove on State Route 128, one mile west of Ross (Venice), Ohio. Check local area map for location. Lots of food, flea market, contests, and model aircraft flying. \$7.00 covers everything. For further information, contact: Jim Wellman, W8HSI, 725 Stout Avenue, Wyoming, Ohio 45215.

HOOSIER ELECTRONICS — Your ham headquarters in the heart of the Midwest where only the finest amateur equipment is sold. Individual, personal service by experienced and active hams. Factory-authorized dealers for Regency, Genave, Drake, Standard, Clegg, Hallicrafters, Ten-Tec, Kenwood, Tempo, Midland, Galaxy, Mosley, Hy-Gain, Cush-Craft, Ham-M, Hustler, plus many more. Orders for in-stock merchandise shipped the same day. Write or call today for our quote and try our personal, friendly Hoosier service. Hoosier Electronics, R. R. 25, Box 403, Terre Haute, Indiana 47802. (812) 894-2397.

FINDLAY ANNUAL HAMFEST, Riverside Park, Findlay, Ohio, Sunday, Sept. 9. Advance donation tickets \$1.00 from C. Foltz, WBUN, W. Hobart, Findlay OH 45840.

TELETYPEWRITERS — Kleinschmidt — portable, fixed, sets, punches, parts, reconditioned, reasonable. Mark/Space Systems, 3563 Conquista, Long Beach, Calif. 90808. 213-429-5821.

EAST CENTRAL ILLINOIS' finest Hamfest. Sunday, September 2 at Douglas Park in Danville, Illinois. Take the Bowman Avenue exit off Interstate 74 and follow the signs. Flea market will open at 6 a.m. Drawing at 3 p.m. Talk in on .34/.94. Camping facilities nearby. Write WA9IAC, 1615 N. Bowman, Danville, Illinois 61832.

MODERNIZE FOR PEANUTS! Frame & Display QSL's with 20 pocket plastic holders. Two for \$1.00, seven for \$3.00. Prepaid, guaranteed. Universally used and approved. Order now. TEPABCO, Box 198H, Gallatin, Tennessee 37066.

ZENERS

All Units Tested And Guaranteed

400 MILLIWATT UNITS — 3, 3.3, 3.6, 3.9, 4.3, 4.7, 5.6, 6.2, 6.8, 7.5, 8.2, 9.1, 18, 22, 24, 27, Volts.
1 WATT UNITS — 10, 11, 12, 13, 15, 16, 18, 20, 22, 27, 30, 33, 39, 43, 47, 51, 56, 62, 68, 75, 82, 91, 100, 110, 120, 130, 150, 160, 180, Volts. **ALL UNITS** 10% — 4 for \$1.00 ppd. 5% — 3 for \$1.00 ppd.

Power Transformer. 115 Volt AC Primary. Secondary #1: 32-0-32 Volt @ 1 Amp. Secondary #2: 6.3 Volts. Low Current For Pilot Lights. Size 2 1/2" x 2 1/2" x 3". Price: \$2.50 Each ppd.

6.3 Volt 1 Amp Transformer. Fully Shielded \$1.60 Each ppd.

Toroids-Unpotted-Centertapped. Your choice — 88 mhy or 44 mhy 5 for \$2.00 ppd. or 15 for \$5.00 ppd.

Transformer — American Made fully shielded. 115 Volt Primary Secondary #1 18-0-18 Volts @ 4 Amps Secondary #2 5 Volts @ 2 Amps A very useful unit for LV Power supply use. Price — A low \$4.75 ppd.

NEW

Transformer — American Made — Fully shielded. 115 V Primary. Sec. — 24-0-24 @ 1 amp with tap at 6.3 volt for pilot light. Price — A low \$2.90 each ppd.

Transformer, 115 VAC Primary, 12 Volt, 4 Amp Secondary \$4.00 Each ppd.

6.3 Volt 1 Amp Transformer. Fully Shielded \$1.60 Each ppd.

115 VOLT TRANSFORMER 17-0-17 Volt @ 150 ma. Secondary With Tap At 6.3 Volts For Pilot Light. \$1.50 Each ppd.

NEW NEW

TRANSFORMER, 115 volt primary, 12 volt 1/2 amp secondary. \$1.50 ppd.



NEW NEW NEW

Factory New Guardian Relay 12 Volt DC Coil 4PDT 5 Amp Contacts Guardian Type 1315P-4C-12D \$2.00 ea. ppd.

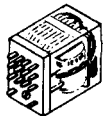

NEW

Factory New Full leads. Fairchild RTL IC's. uL 900, uL 914, uL 923. YOUR CHOICE 3 for \$1.00 ppd.

NEW

NEW NEW

Transformer — 115 Volt Primary — 12 Volt 1.2 Amp Secondary \$2.45 ppd.

TI 1N914 16 for \$1.00

1N270 5 for \$1.00

SEND STAMP FOR BARGAIN LIST Pa. residents add 6% State sales tax ALL ITEMS PPD. USA

m. weinschenker
 K 3DPJ BOX 353 · IRWIN, PA. 15642

REEDLESS ENCODER



- SUB-AUDIBLE
- -30 TO 65°C OPERATION
- FAST STARTING TIME
- RF SHIELDED
- OPERATES ON 9 TO 18 VDC
- SMALL SIZE ONLY 1.3" SQ x 1/2" HIGH

\$ 28.50 AVAILABLE FOR ANY EIA CODE 67.0 THRU 192.8 Hz

WRITE FOR COMPLETE SPECS AND DATA SHEET

Tobel ELECTRONICS

7920 Alida St La Mesa California 92041

F.C.C. EXAM MANUAL

PASS FCC EXAMS! Memorize, study — "1973 Tests-Answers" for FCC First and Second class Radio-telephone licenses. Newly revised multiple-choice questions and diagrams cover all areas tested in FCC exams. — plus "Self-Study Ability Test." \$9.95 Postpaid.



COMMAND PRODUCTIONS P.O. BOX 26348-K
RADIO ENGINEERING DIVISION SAN FRANCISCO, CALIF. 94126

WORLD QSL BUREAU

THE ONLY QSL BUREAU to handle all of your QSLs to anywhere; next door, the next state, the next country, the whole world. Just bundle them up (please arrange alphabetically) and send them to us with payment of 5¢ each.

5200 Panama Ave., Richmond, CA USA 94804

SB-144 2 meter FM TRANSCEIVER



12 CHANNEL 10 WATT 2 METER FM TRANSCEIVER COMPLETE WITH 3 SETS CRYSTALS MICROPHONE, MTG. BRACKET

List 259.95 Your Cost 199.95 FOB Houston

MADISON ELECTRONICS SUPPLY
1508 MCKINNEY AVE. • HOUSTON, TEXAS
713/224-2668

GATEWAY ELECTRONICS

8123 PAGE AVENUE
ST. LOUIS, MISSOURI 63130
314-427-6116

- L.E.D. 7 SEGMENT READOUT — MAN 1 TYPE — NEW \$2.75
- L.E.D. SINGLE SEGMENT — STANDARD SIZE — RED — NEW 35¢ 3/\$1.00
- MINIATURE CIRCUIT BREAKERS — 1 1/2 x 1 1/4 x 1/2 — Resetable — push button — 4, 5, 7, 10 or 20 amp available — single hole mount 50¢ 5/\$2.00
- THUMBWHEEL SWITCHES
 - 0.5 x 2.125 x 1.78 — 10 position decimal \$3.00
 - 10 position BCD & Compliment \$4.00
 - End Plates (per pair) \$1.45
- MINIATURE SIZE
 - 0.312 x 1.3 x 1.3 — 10 position decimal \$2.50
 - 10 position BCD & Compliment \$3.75
 - End Plates (per pair) \$1.00
- 2N3055 — NPN SILICON POWER TRANSISTORS \$1.25
- 600 PIV — 2 AMP BRIDGE RECTIFIER \$1.00
- 5 MHz MINIATURE CRYSTAL — WIRE LEADS \$2.50
- 10 MHZ CRYSTAL — Type CR6/U in 24 volt oven \$2.50

\$5 Minimum Order.

Visit us when in St. Louis.

Please include sufficient postage.

NOW

EXCLUSIVE 66 FOOT **MDR & AIN** 75 THRU 10 METER DIPOLE
NO TRAPS — NO COILS — NO STUBS — NO CAPACITORS
Fully Air Tested — Thousands Already in Use



IS BACK

#16 40% Copper Weld wire annealed so it handles like soft Copper wire—Rated for better than full legal power AM/CW or SSB-Coaxial or Balanced 50 to 75 ohm feed line—VSWR under 1.5 to 1 at most heights—Stainless Steel hardware—Drop Proof Insulators—Terrific Performance—No coils or traps to break down or change under weather conditions—Completely Assembly ready to put up—Guaranteed 1 year—ONE DESIGN DOES IT ALL; 75-10HD—ONLY \$12.00 A BAND!

Model 75-10HD ... \$60.00 ... 66 Ft. ... 75 Thru 10 Meters
Model 75-20HD ... \$50.00 ... 66 Ft. ... 75 Thru 20 Meters
Model 80-40HD ... \$42.00

Model 75-40HD ... \$40.00 ... 66 Ft. ... 75 Thru 40 Meters
Model 40-20HD ... \$33.00 ... 35 Ft. ... 40 Thru 20 Meters
69 Ft. 80-40-15 Meter (CW)

ORDER DIRECT OR WRITE FOR FULL INFORMATION

MDR & AIN

300H Shawnee
Leavenworth, Kansas 66048

OR THRU YOUR FAVORITE DISTRIBUTOR

GLOBAL RESEARCH & SUPPLIES. SBE SB-50 \$349.95, SB3-AC \$42.50. Hy-Gain 6 meter linear, 220 watts, mobile #404 \$129.95, base \$109.95. Tempo 6N2 KW linear \$595.00. Genave GTX-2 \$249.95. GTX-10 \$199.95. GTX-200 \$259.95. Comcraft CTR-144 \$489.00. Write for catalog, P. O. Box 271, Lombard, Ill. 60148. 312-279-4658.

PRINTED CIRCUIT DRILL BITS. Trumbull, 833 Balra Drive, El Cerrito, California 94530.

TECH MANUALS for Govt. surplus gear — \$6.50 each: R-389/URR, R-390/URR, URM-25D, RCK, TT-63A/FGC, CV-591A/URR, TS-497B/URR, R-220/URR, TS-34A/AP, ALR-5, URM-32, USM-16, TS-403/U. Hundreds more available. Send 50¢ (coin) for large 20-page list. W31HD, 7218 Roanne Drive, Washington, D. C. 20021.

WE BUY ELECTRON TUBES, diodes, transistors, integrated circuits, Semiconductors. Astral Electronics, 150 Miller Street, Elizabeth, New Jersey 07207, (201) 354-2420.

WESTERN UNION DESK-FAX TELEFAX Transceiver Manual: Complete theory of operation, adjustment, lubrication, preventive maintenance, troubleshooting, parts list. Includes all schematics and mechanical parts drawings. \$3.80 postpaid. Bill Johnston, 1808 Pomona Drive, Las Cruces, New Mexico 88001.

QSL'S — BROWNIE W3CJI — 3111B Lehigh, Allentown, Pa. 18103. Samples 10¢. Cut catalogue 25¢.

FOR SALE: HEATHKIT SB-300, mint condition, all new tubes, has scarcely been used, \$200. Eico 720 transmitter, mint condition, with 722 VFO, the perfect novice transmitter, \$100. Model 19 Teletype machine, with unshift on space, 75 wpm gears, 60 wpm gears, \$135. Marsan television camera, fast-scan, video or RF output, adaptable to SSTV, \$180.00. All prices are plus shipping. C. Fine, WB2CNH, 570 North Street, Harrison, New York 10528. Tel: 914-967-2652.

USED MYLAR TAPES — 1800 foot. Ten for \$8.50 postpaid. Fremerman, 4041 Central, Kansas City, Mo. 64111.

DO-IT-URSELF DXPEDITION — Stay at ZF1SB-Cayman Is. Vertical antenna and Caribbean at your doorstep. Diving/fishing if band folds. we arrange license. Write Spanish Bay Reef Resort, Box 800K, Grand Cayman, B. W. I.

BECKMAN MDL 1453 recorder vg. \$90.00; Beckman 1453 with 4005 scanner vg., \$120.00; HP/Sanborn twinviso with gears, manual and most attachments in cabinet, \$130.00; WE RO67/FSA-14 oscillograph, g.vg. \$24.00; Cleary printers 16 column, 15 lines per second. One good, \$115.00, one better, \$130.00; Librascope Mdl 200B XY plotter, \$105.00; Amperex NRZ amplifiers for GS 80 as new, \$20.00. Douglas Craton, 5625 Balfrey Dr., W. Palm Beach, Fla. 33406.

WASHINGTON, MISSOURI — Zero-Beaters ARC Annual Hamfest, August 5, over \$700.00 prizes. Ham auction, large traders row, entertainment for XYL and children. St. Louis ARC Ham of the Year Award. Missouri Army MARS meeting. Write Zero-Beaters ARC, Box 24, Dutzow, Missouri 63342 for tickets and information.

CANADA'S MOST UNUSUAL Surplus and Parts Catalog. Jam packed with bargains and unusual items. Send \$1. ETCO-HR, Box 741, Montreal, Canada.

MIX PLEASURE WITH PLEASURE. 1973 Hamburg International Hamfest on September 15, only 45 minutes from fabulous Niagara Falls. RV parking for weekend only \$2.50 with hook-up. Details: Valerie Orgera, K2KQC, 187 Main, Hamburg, N. Y. 14075.

EMBROIDERED EMBLEMS AND PATCHES. Custom made from your design. 10 to 1000's. Write Russell, 1109 Turner St., Augusta, Maine 04210.

THE KANSAS-NEBRASKA RADIO CLUB, Concordia, Kansas, presents their 22nd annual KNRC Hamfest on Sunday, August 5, 1973 at the Moose Building, 113 W. 5th St. There will be a mobile talk-in on 3920kHz and on 146.94 or .94-34 repeater. Bring your favorite covered dish, free soft drinks, swap tables. Registration begins at 9:00 a.m.

L. I. Electronic Supermart (Off the wall self service)

New P.C. Boards — G10, 1 oz. - 1 side copper-fiber glass

6" x 6", 80¢ ea. — 6 x 12, \$1.50 ea. - 12 x 12, \$2.85 ea.

New P.C. Boards — G10, 1 oz. - 2 side copper-fiber glass

6" x 6", \$1.10 ea. - 6 x 12, \$2.00 ea. - 12 x 12, \$3.75 ea.

New P.C. Boards — G10, Fiber glass punch:

F Pattern 4.5 x 6.5, .062 holes, 5 per 1" \$1.30

P Pattern 4.5 x 6.5, .042 holes, 10 per 1" \$1.35

G Pattern, 4.5 x 6.5, .062 holes, \$1.30

Pkg. 10 Bircher P.C. Board, metal 2" slides \$1.00

Package of 50 flea clips for above punched Boards, .062 75¢

30 ¼ or ½ W resistors, packaged 5 per value \$1.00

your choice of values \$1.00

25-1W resistors, packaged 5 per value, your choice of values \$1.00

15-2W resistors, packaged 5 per value, your choice of values \$1.00

5 ¼ or ½ W, 1% resistors, packaged 5 per value, your choice of values \$1.00

5 ceramic disk caps, .001-01, packaged 5 per value, your choice of values \$1.00

5 mica dip caps, 1 pf-150 pf, packaged 5 per value, your choice of values \$1.00

5 mica dip caps, 180 pf-820 pf, packaged 5 per value, your choice of values \$1.00

5 mica dip caps, 910 pf-1500 pf, packaged 5 per value, your choice of values \$1.00

Wire Kit #22 solid PVC, 6 spools, 6 colors, 50' ea. spool \$3.50

Wire Kit #22 stranded PVC, 6 spools, 6 colors, 50' ea. spool \$3.50

Wire Kit #24 Solid PVC, 6 spools, 6 colors, 50' ea. spool \$3.50

Wire Kit #24 stranded PVC, 6 spools, 6 colors, 50' ea. spool \$3.50

10' — Ten cond. ribbon wire, color coded, #22 or #24, stranded \$1.50

C & K #7101 mini switch, SPDT on-on \$1.05

C & K #7103 mini switch, SPDT on-off-on \$1.20

C & K #7201 mini switch, DPDT on-on \$1.35

C & K #7203 mini switch, DPDT on-off-on \$1.55

Alco 105D MST momentary on-off-momentary \$1.25

Central Lab DPDT push momentary, SPEC. 4/\$1.00

Connectors, PL259, \$4.45; PL258, \$7.00; 175U or 176U, \$2.0 ea.; UG 88 cu, \$5.00; UG 201 a/u (N to BNC adapter) \$7.75; RCA to UHF, \$9.00

Encapsulated chokes 1uh to 5 Mh, choice 3/\$1.00

Vario type mini bridge rectifiers, approx. ¼" sq. size: 2 amp. - 50 v., \$1.25; 4 amp. - 50 v., \$1.25; 6 amp. - 50 v., \$1.25; 2 amp. - 100 v., \$1.25; 4 amp. - 100 v., \$1.25; 6 amp. - 100 v., \$1.25; 2 amp. - 200 v., \$1.50; 4 amp. - 200 v., \$1.50; 6 amp. - 200 v., \$1.50; 2 amp. - 400 v., \$1.50; 4 amp. - 400 v., \$1.50; 6 amp. - 400 v., \$1.50

Triacs — thermo tab package — 1 amp. - 400 v., \$8.0 ea.; 3 amp. - 400 v., \$14.0 ea.; 4 amp. - 200 v., \$1.20 ea.; 6 amp. - 200 v., \$1.40 ea.; 6 amp. - 400 v., \$1.60 ea.; 6 amp. - 500 v., \$1.80 ea.; 8 amp. - 200 v., \$1.60 ea.; 8 amp. - 500 v., \$1.80 ea.

Tu-5 case, 1 amp. - 200 v., \$7.0 ea.; 1 amp. - 400 v., \$1.00 ea.

SCR 200 v. - 8 amp. thermo tab \$8.0 ea.

SEND SELF ADDRESSED ENVELOPE FOR FREE MAILER. INCLUDES MANY HUNDREDS OF ITEMS NOT LISTED ABOVE.

Send check or money order - include 60¢ to cover parcel post and handling. UPS shipping available. Minimum order \$4.50.

FREE BONUS WITH EACH \$10.00 ORDER

50' SPOOL 600 V. #22 PVC WIRE

KRP

ELECTRONIC SUPERMART, INC.

219 WEST SUNRISE HIGHWAY

FREEPORT, L. I., N. Y. 11520

516-623-3346-9

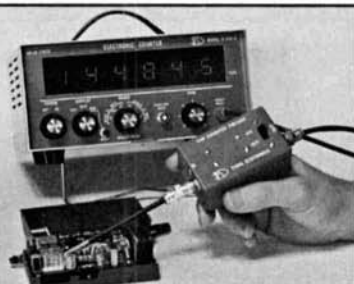

THE EASIEST WAY YET...

To measure frequency to 250 MHz. Thru-line feature for transmitters, preamp and probe for receiver crystals. The 20dB gain preamp may be purchased separately for use with any counter. Write for details.

VHF Counter preamp w/probe \$35.00 ppd

Model 6-VHF-A Counter \$350.00



PAGEL ELECTRONICS

6742-C TAMPA AVENUE
RESEDA, CALIF. 91335

WANTS TO BUY

All types of military electronics equipment and parts. Call collect for cash offer.

**SPACE ELECTRONICS division of
MILITARY ELECTRONICS CORP.**

76 Brookside Drive, Upper Saddle River
New Jersey 07458 • (201) 327-7640

CRYSTAL BARGAINS

Depend on . . .

We supply crystals from
16kHz to 100MHz. Over
6 million crystals in
stock.



DIVISION OF BOB
WHAN & SON
ELECTRONICS, INC.

2400 Crystal Dr.
Fort Myers
Florida 33901
(813) 936-2397

SPECIAL

Crystals for most amateur
2-Meter F.M. Transceivers:

\$3.75 Each

Inquire about quantity
prices. Order direct. Send
check or money order.

For first class mail add 15¢ per
crystal...for airmail add 20¢ ea.

Send 10¢ for new
catalog with
oscillator circuits
and lists of
thousands of
frequencies in
stock.

SPECIALS! CRYSTALS FOR:

Frequency Standards	
100 KHz (HC13/U)	\$4.50
1000 KHz (HC6/U)	4.50
Almost All CB Sets, Trans. or Rec. (CB Synthesizer Crystal on request)	2.50
Any Amateur Band in FT-243	1.50
(Except 80 meters)	4 for 5.00
80 Meter Range in FT-243	2.50
Color TV 3579.545 KHz (wire leads)	1.60
	4 for 5.00

USED TEST EQUIPMENT

All checked and operating unless otherwise noted. FOB Monroe. Money back (less shipping) if not satisfied.

Boonton 190A Q-mtr 20-260 MHz Q5-1200	375
GR546C Audio Microvolter 5uv-1v	85
GR1302A Audio Osc.-low distortion	125
HP100D-Freq. stand. w/scope-Acc. 1ppm	125
HP100ER Freq. stand. w/scope-Acc. .05ppm	195
HP185A Scope w/186B amp sampling 1GHz	335
HP330C Dist anal 20 Hz-20kHz 1%	225
HP540B Trans osc. for 524 to 12.4GHz	185
HP608D (TS510A/U) sig. gen. 10-420 MHz	450
Kay 860A Vari-sweep 2-215MHz. cal. attn	175
Nems Clark 1671 FM rcvr 175-260MHz	125
NLS484A Dig DC voltmtr -.01% acc.	65
Polarad R wave rcvr 4-84GHz with plug-in FM, CW, Pulse — less plug-in	285
Polarad TSA Spec. Anal. .01-44GHz with plug-in — less plug-in	325
Republic VA260 Q-mtr (sim. Boonton 160A)	185
Soliton 200A SCR tester-checks anode, gate volts current, leakage and holding	165
Stoddard NM10A (URM-6) RF intens mtr 10- 250 kHz, complete with acc.	630
Stoddard NM20A (PRM-1) RF intens mtr 15- 25MHz, complete with acc.	825
Stoddard NM52A-RFI mtr, .375-1GHz, w/ acc.	985
Tek RM15-DC-15MHz GP scope	295
Tek 181 Time mark generator	95
Tek 190A Const. Ampl. Sig. Gen. .35-50MHz	125
Tek 531 DC-15MHz scope-takes letter plug-in	360
FR6/U Freq. mtr .001% acc 100-500MHz	145
SG24/TRM3 Sweep Gen. 15-400 MHz, CW, AM, FM Xtal markers, scope-Dev. to 20%	245
TS-403A-Sig. Gen. (HP616) 1.8-4GHz	385
URM 7 RI-FI mtr (sim. NF-105) 20-400MHz	750
USM24C Scope-8MHz, time-base, triggered	125

(Send SASE for complete list)

GRAY Electronics

P. O. Box 941, Monroe, MI 48161

Specializing in used test equipment

ACTIVE AUDIO FILTERS

IC's FOR SUPER
HIGH PERFORMANCE

CW FILTER (CWF-2)

Get razor sharp selectivity;
No impedance matching! BW
(selectable) 80 Hz, 110 Hz,
180 Hz; Center frequency
F=750 Hz; Skirts 60 dB
down at 1/2 F and 2F; 4
op amps; 2" x 3" PC
board; \$14.95 wired, test-
ed, guaranteed; \$12.95 kit.



CWF-2: \$12.95 KIT

CW MINI FILTER (CWF-3)

\$14.95 WIRED
1 1/2" x 2" PC board; Center frequency F=750 Hz; 30 dB
down at 1/2 F and 2F; BW 110 Hz, 180 Hz; 2 op amps;
\$8.95 wired, tested, guaranteed; \$7.95 kit.

LOW PASS FILTER (LFP-1)

Resistors set cutoff 500 Hz to 20 kHz; Factory set to 2.5
kHz; Roll-off 48 dB per octave; Input imp 1 M; Gain=1;
5 op amps; 2" x 3" PC board; \$16.95 wired, tested,
guar.; \$14.95 kit. Please include 55¢ postage on all orders.

MFJ ENTERPRISES

Send for FREE Spec Sheet
PO 494-A, Miss. State, MS 39762

YAESU

Racom has the following Yaesu models
in stock for immediate delivery.

**FT-101, FTDX-570 & 401,
External VFO's, Speaker-Patches
Frequency Counters.**

Also 2 Meter FM Mobile Transceivers
FT-2FB and FT-2 Auto

Write to Woody, W7RC

Racom Electronics, Inc.

15051 S.E. 128 ST., RENTON, WA. 98055
Telephone 206-AL5-6656

COMPLETE REPAIR SERVICE

RECIPROCATING DETECTOR KIT, write Peter Meacham Associates, 19 Loretta Road, Waltham, Mass. 02154.

DELMARVA HAMFEST, August 19, 1973, Harrington Fairgrounds. Registration fee \$2 advance, \$3 at the gate. For information write Delmarva Hamfest, Inc., Route 2, Box 90, Laurel, Delaware 19956.

VERY in-ter-est-ing! Next 6 big issues \$1. "The Ham Trader," Sycamore IL 60178

ROANOKE DIVISION CONVENTION — Sept. 14-16, 1973, Reston, Va. (near Dulles Airport). Unusual wide interest programs and sessions. Write K4MD, Box 7388, Warrenton, Va. 22186.

KENTUCKY HAMFEST — The Greater Louisville Hamfest will be held August 26, 8:00 a.m. to 6:00 p.m. at the Oldham County Fairgrounds, LaGrange, Kentucky, on S. R. 146 off I-71. Admission and registration \$1, flea market \$1.5 major prizes, door prizes, ladies program, food and refreshments, plenty of parking. Contact: Guy E. Partridge, K4KZH, 8276 Walker Road, Louisville, 40258.

FIGHT TVI with the RSO Low Pass Filter. For brochure write: Taylor Communications Manufacturing Company, Box 126, Agincourt, Ontario, Canada. MIS 3B4

WIRE WRAPPING TOOL \$1.00. All DIP size wrap panels \$5.00 up. Xycon, Box 9341, Phoenix, Az. 85020.

100 kHz CRYSTALS, octal base. \$2.50 postpaid. Limited supply. Nat Stinnette Electronics, Tavares, FL 32778.

SBE 36, 9 mo. old mint transceiver 500 PEP digital read out 80-10 \$595. Peter Williamson, K1RES, 132 Winthrop St., Augusta, Maine 04330, 622-1949 after 5.

WANTED: Lafayette HA46, Bob, K6GEV, 11 Wool, San Francisco 94110.

PLASTIC ENGRAVED CALL PLATES, w/pin \$1.25. WA2UUY, 15 Vincent St., Parlin, N. J. 08859.

HOME BREWERS: Stamp brings list of high quality components. CPO Surplus, Box 189, Braintree, Mass. 02184.

MODEL 28KSR with LK38BRR variable speed keyboard model 14 typing-reperf and TD. All \$250 FOB, firm. K5YBT, P. O. Box 631, Vidalia, La. 71373, 318-336-7496.

YAESU TRANSCEIVER OWNERS — present and prospective. Join the international Fox-Tango Club. Send business-size SASE or IRC for information and sample Newsletter. Milton Lowens WA2AOQ, 3977-F Sedgewick Ave., Bronx, N. Y. 10463.

NEW AC LINE MONITOR. Plugs into AC outlet. 1 volt accuracy. 105-125 VAC \$18.00 ppd. L. M. Hamilton, 19509 Flavian Ave., Torrance, Ca. 90503.

TELETYPE MACHINES by Kleinschmidt. Page printer with power supply, as received from Govt., \$59.95. Single tables, excellent condition, \$19.95. Page printer and reperf combination, as received from Govt., \$59.95 ea. Double tables, excellent with chad box and tape compartments for \$34.95. Each of the above TT machines cleaned, oiled, and adjusted please add \$30.00 ea. TH-5 converters, transmit and receive on 170 shift, \$49.95. Paper winders \$14.95. Freight is collect on all orders. Andy Electronics, Inc., 6431 Springer, Houston, Texas 77017.

CALCULATOR OWNERS: Use your +-X-÷ calculator to compute square roots, trigonometric functions, logarithms, exponentials, and more; quickly, accurately, easily! Manual \$2.00. Mallmann Optics and Electronics, Dept.-A, 836 South 113, West Allis, Wisconsin 53214.

MANUALS for most ham gear made 45/65, some earlier. Send SASE for copy quote. Hobby Industry, W0JJK, Box 864, Council Bluffs, Iowa 51501.

YOUR AD belongs here too. Commercial ads 25¢ per word. Non-commercial ads 10¢ per word. Commercial advertisers write for special discounts for standing ads not changed each month.

NURMI ELECTRONIC SUPPLY

1727 Donna Road • West Palm Beach, Fla. 33401

PHONE — (305) 686-8553

HEP 170 — 2½ Amp, 1,000 Volt diodes. Factory packs of 10. Free HEP Cross Reference with HEP 170 order.

10/\$3.00 — 100/\$25.00

COMPUTER GRADE ELECTROLYTIC CAPS

Screw

Terminals —



1,400mf	100V	\$1.25	18,000mf	10V	\$1.10
2,000mf	50V	1.10	29,000mf	10V	1.25
3,000mf	35V	1.00	34,000mf	50V	2.00
3,400mf	25V	1.00	39,000mf	10V	1.35
4,800mf	25V	1.25	90,000mf	20V	2.00
6,000mf	10V	.95	240,000mf	10V	3.00

TO — 5 SIZE TRIM POTS — Spectrol No.

82-3-8 or equivalent. Available values:

100, 250, 500, 1,000, 2,000, 5,000

ohms. Mix or match price only:

10/\$5.00 — 25/\$10.00 — 100/\$30.00

BELDEN TEST LEAD WIRE — 20KV break-

down, 5KV Working, 18 ga., super flex-

ible, Available in Red, Black, Gray, Blue,

White, Yellow & Green. Designed for

meter leads, test leads, clip leads, etc.

Cut to your length. Minimum of 10 feet

per color. Factory Fresh! Belden No.

8899. 6¢/Foot — 100 Ft./\$5.00

RCA 40673 DUAL GATE MOS FET —

Only — 5/\$6.00

MAGNET WIRE — SUPER SPECIAL —

Sold by the spool. 16ga-32ga average

spool 7 lbs. 33ga-47ga average spool

2 lbs. ONLY:

16-32 ga. spool \$5.00

33-47 ga. spool \$1.50

— TAKE 20% OFF

\$20 MAGNET WIRE ORDER —

26 GAUGE TWISTED PAIR TEFLON WIRE

— Tinned, solid, great hook-up and

speaker wire. 1,100 foot factory sealed

spools. Only \$4.75

GLASS EPOXY PERFBORAD — .1" x .1"

centers, .042" dia. holes. Designed for

IC work. Mfg.: Keystone

Size: 2" x 4½" \$.85

" 2" x 6" 1.09

" 4½" x 6" 1.55

" 6" x 17" 5.75

CONNECTORS: UHF SERIES —

PL-259, SO-239 10/\$4.50

UG-175/U Reducer 10/\$1.50

M-358 Tee \$2.75 ea.

M-359 Elbow \$1.50 ea.

PL-258 Barref \$1.20 ea.

WE ARE FACTORY AUTHORIZED DISTRIBUTORS

FOR MOTOROLA, BELDEN, KEY-

STONE, PHILMORE, AIRCO SPEER, etc.

— WE GUARANTEE WHAT WE SELL!!!! —

We ship UPS whenever possible. Give street ad-

dress. Include enough postage, excess refunded

in cash. Florida residents include 4% Tax.

AK-1 BOARD ONLY	\$ 3.25
AK-1 KIT OF ELECTRONIC PARTS	\$ 20.00
ST-5 BOARDS ONLY	\$ 5.25
ST-5 KIT OF ELECTRONIC PARTS	\$ 47.50
ST-5A BOARDS ONLY	\$ 5.25
ST-5A KIT OF ELECTRONIC PARTS	\$ 54.00
ST-6 BOARDS ONLY (These are the 8 original by W6FFC)	\$ 18.00
ST-6 KIT OF ELECTRONIC PARTS	\$128.50
MOD. KIT FOR UPDATING THE ST-5 TO THE ST5A	\$ 9.00
PEMCO 250 EIGHT DIGIT COUNTER WITH BUILT-IN PRE-SCALER AND POWER SUPPLY SEMI KIT	\$165.00
PEMCO MODEL 50A FREQUENCY COUNTER SEMI-KIT	\$125.00

These are fully assembled and tested boards only, you add your own cabinet, etc. Write for details.

You must supply the cabinet, A.C. cord, meter, switches, etc. on all kits except where noted otherwise. (All prices are postage paid (we pay shipping).

We will do most any printed circuit board for individuals or prototypes. If required we will also do the layout of the boards. All our boards are G-10 glass-epoxy solder plated and come drilled only. At present time we can do only single sided. All component parts used in our kits are new manufacturers stock. We Do Not Use Any Used or Surplus Parts. All inquiries are answered promptly.

PEMCO ELECTRONICS
ELECTRONICS
MANUFACTURING
422 18th St., N.E., Salem, Ore. 97301, (503) 585-1641

THE ULTRA-BAL 2000

NOW -----An extremely rugged, weather-proof BALUN!
 • Full 2KW, 3-30 MHz., 1:1 or 1:4 ratios.
 • Special Teflon insulation. May be used with tuned lines and tuners.
 • With dipole insulator and hang-up hook.

ONLY \$ 8.95 p.p.d. (state rate)
At your dealer or order direct

K.E. Electronics Box 1279, Tustin Calif. 92680

SSB CONVERTER CV-591A: Get upper or lower sidebands from any recvr. OK gtd. w/book \$137.50
 SP-600(*) RECEIVER 0-54.54 MHz continuous, overhauled, aligned, grtd, w/book \$250.00

BRAND NEW FREQ-SHIFT TTY MONITOR

NAVY OCT 3: FM Receiver type, freq. range 1 to 26 MHz in 4 bands, cont. tuning. Crystal calib. Reads up to 1500 Hz deviation on built-in VTVM. Cost \$1100.00 each! In original box, with instruct. book & cord. fob Mariposa, Cal. Min. signal needed: 15 mv. Shpg wt 110 lbs. \$49.50

HIGH-SENSITIVITY WIDE-BAND RECEIVER

COMMUNICATIONS • BUG DETECTION
• SPECTRUM STUDIES

38-1000 MHz AN/ALR-5; Consists of brand new tuner/converter CV-253/ALR in original factory pack and an exc. used, checked OK & grtd main receiver R-444 modified for 120 v. 50/60 Hz. The tuner covers the range in 4 bands: each band has its own Type N Ant. input. Packed with each tuner is the factory inspector's checkout sheet. The one we opened showed SENSITIVITY: 1.1 uv at 38.4 MHz, 0.9 at 133 MHz, 5 at 538 MHz, 4 1/2 at 778 MHz, 7 at 1 ghz. The receiver is actually a 30 MHz IF ampl. with all that follows, including a diode meter for relative signal strengths: an atten. calibrated in 6 dB steps to -74 dB, followed by an AVC position; Pan., Video & AF outputs; switch select pass of ±200kHz or ±2 MHz; and SELECT AM or FM! With Handbook & pwr. input plug, all only \$375.00

30 MHz PANADAPTER OK grtd \$137.50

NEMS-Clarke #1670 FM Rcvr 55-260 MHz like new \$275.00

Attention!

Buyers, Engineers, advanced Technicians:

We have the best test-equipment & oscilloscope inventory in the country so ask for your needs . . . don't ask for an overall catalog . . . we also buy, so tell us what you have. Price it.

R. E. GOODHEART CO. INC.

Box 1220-HR, Beverly Hills, Calif. 90213

Phone: Area Code 213, Office 272-5707

LEARN RADIO CODE



THE EASY WAY!

- No Books To Read
- No Visual Gimmicks To Distract You
- Just Listen And Learn

Based on modern psychological techniques—This course will take you beyond 13 w.p.m. in LESS THAN HALF THE TIME! Available on magnetic tape \$9.95 — Cassette, \$10.95

\$9.95

Album contains three 12" LP's 2 1/2 hr. Instruction

EPSILON [E] RECORDS

508 East Washington St., Arcola, Illinois 61910



KM-420 CW MESSAGE MEMORY 100 OR 200 CHARACTERS... \$299.95 Write for Brochure
 EK-420 C-MOS DELUXE KEYS FOR QRP OR KW... \$139.95

GURMS ELECTRO DEVICES TEL: (415) 964-3136 INC. BOX 4090, MOUNTAIN VIEW, CA. 94040 **NEW FOR 1973**

SPACE-AGE TV CAMERA KITS & PLANS



BE A PIONEER IN HOME TELECASTING! Build your own TV CAMERA: Model XT-1A, Series D, \$116.95 pp. Solid-State. Step-by-step construction manual. High quality. Connects to any TV without modification. Ideal for home, experimenters, education, industry, etc.

PHONE OR WRITE FOR CATALOG.
DIAL 402-967-3771

Many other kits, parts and plans available including starter kits, focus, defl. coils, vidicon tubes, const. plans, etc.

1301 BROADWAY, N.W. **ATV Research** DAKOTA CITY, NEBR. 68731

Measure Frequencies to 500 MHz!



Beat the high cost of UHF/VHF frequency measurements. Our prescalers divide frequencies up to 500 MHz exactly by 10, 20, or 100 — permitting use of your low-frequency digital counters. Absolutely no drift or errors — 100 mv input sensitivity — 3 volt pulsed output to operate any standard counter. Three popular models to fit your needs.

- PS-510 DIVIDE-BY-TEN to 500 MHz and DIVIDE-BY-ONE HUNDRED to 500 MHz (dual range) — \$229.50
- PS-502 DIVIDE-BY-TEN to 300 MHz and DIVIDE-BY-TWENTY to 500 MHz (dual range) — \$149.50
- PS-170 DIVIDE-BY-TEN to 300 MHz — \$59.50

Micro-Z Co.

Box 2426 Rolling Hills, Calif. 90274

'HAM' UHF 400 MC HIGH POWER TRANSISTORS

3 for \$10. **\$3.95**
By RCA or equal 2N3632. NPN, 23 watts, 3 amps. TO-60 case, with stud mtg. VCEV max 66.

\$2.95 LED

This display is excellent for small portable electronics, such as DVM's, calculators, etc. Equivalent to Monsanto MAN 3A. Operates from 5V, 20 milliamperes, with 47 ohm dropping resistor.

6-DIGIT MAN-3A MUX'D PC BOARD

Clock DCMs, VTVM, DVM, calculators, multiplexed. 6-MAN-3A's for above board, \$9.50.

LED 7-SEGMENT MAN-4 EQUAL READOUTS

Snaps in 14-pin DIP socket. 3/16" x 1/8" x 3/32". Snaps in 14-pin DIP socket. Like MAN-1.

SILICON TUBES

5U4	\$1.49
5R4	3.95
666	7.95

OPCOA'S MAN-1

Same size, and characteristics as MAN-1. 5V 20 mils, 7-segment, 0-to-9 etc. Except character size 0.33. \$3.50

HIGH POWER TRANSISTOR WITH HEAT SINK \$1.98

CALCULATOR KEYBOARD \$12.50

Properly etched, drilled, "MULTIPLExED" with proper diodes. Ready to go! Used with our own CAL TECH'S 5001 chip advertised at \$12.95 or equal to Cal Tech or Mostek chip. Keyboard uses the new manufactured by OAK, printed-circuit low-profile FEATHER TOUCH switches. Size: 6 1/2 x 4 1/2 x 1/4".

SWITCHES

Lowest Prices Largest Selection TTL IC's

Type	Sale	Type	Sale	Type	Sale	Type	Sale
SN7400	\$0.30	SN7438	.60	SN7481	1.50	SN74145	1.40
SN7401	.30	SN7440	.30	SN7482	.95	SN74151	1.25
SN7402	.30	SN7441	1.40	SN7483	1.50	SN74153	1.60
SN7403	.30	SN7442	1.25	SN7485	1.41	SN74154	2.10
SN7404	.35	SN7443	1.35	SN7486	.55	SN74155	1.55
SN7405	.32	SN7444	1.35	SN7489	3.75	SN74156	1.55
SN7406	.55	SN7445	1.35	SN7490	1.30	SN74157	1.55
SN7407	.55	SN7446	1.65	SN7491	1.50	SN74158	1.55
SN7408	.35	SN7447	1.65	SN7492	1.10	SN74160	1.95
SN7409	.35	SN7448	1.50	SN7493	1.10	SN74161	1.95
SN7410	.30	SN7449	1.50	SN7494	1.10	SN74162	1.95
SN7411	.35	SN7450	.35	SN7495	1.10	SN74163	1.95
SN7412	.35	SN7451	.35	SN7496	1.10	SN74164	3.50
SN7413	.35	SN7452	.35	SN7497	1.10	SN74165	3.50
SN7414	.35	SN7453	.35	SN7498	1.10	SN74180	1.20
SN7415	.35	SN7454	.35	SN7499	1.10	SN74181	4.50
SN7416	.35	SN7455	.35	SN7500	1.10	SN74182	1.20
SN7417	.55	SN7460	.35	SN7501	1.10	SN74184	2.50
SN7418	.55	SN7464	.50	SN7502	1.10	SN74185	2.50
SN7419	.30	SN7465	.50	SN7503	1.10	SN74192	1.95
SN7420	.30	SN7470	.50	SN7504	1.10	SN74193	1.95
SN7421	.30	SN7472	.35	SN7505	1.10	SN74194	1.95
SN7422	.35	SN7473	.65	SN7506	1.10	SN74195	1.95
SN7423	.35	SN7474	.65	SN7507	1.10	SN74196	2.65
SN7424	.30	SN7475	1.30	SN7508	1.10	SN74197	2.65
SN7425	.30	SN7476	.75	SN7509	1.10	SN74198	2.65
SN7426	.30	SN7477	.75	SN7510	1.10	SN74199	2.65
SN7427	.30	SN7478	.75	SN7511	1.10	SN74200	9.99
SN7428	.30	SN7479	.75	SN7512	1.10		
SN7429	.30	SN7480	.75				

INTEGRATED CIRCUIT SOCKETS

- Buy Any 3 - Take 10% Discount!
- 14-Pin, dual in line \$45
- 16-Pin, dual in line \$50
- TO-5, 8 or 10 pins .29

NATIONAL 'OP' AMPS

Type	Description	Sale
LM-300	Super 723 V. reg.	\$1.49
LM-301	Hi-performance amp	.49
LM-302	Voltage follower	1.49
LM-304	Neg. V. reg.	1.49
LM-305	Pos. V. reg.	1.49
LM-307	Super gain op amp	.59
LM-309H	5V 200 mil V. reg.	1.50
LM-309K	5V 1-amp V. reg.*	2.25
LM-311	Comparator	1.50
LM-320	Minus 5V amp V.R.*	2.95
LM-320	Minus 12V 1-amp V.R.*	2.95
LM-320	Minus 15V 1-amp V.R.*	2.95
LM-350	Dual peripheral driver	.59
LM-370	AOC squeelch op amp	1.49
LM-373	AM FM, 558, I-F strip	3.75
LM-380	2-watt audio amplifier	1.95

LITRONIX FDL-7 LED 7-SEGMENT READOUT 4.50

Pin-for-pin substitute for famous MAN-1. Electrically the same. Snaps into 14-pin DIP socket. Requires same drivers, i.e., SN7416 or SN7447. Requires 5V @ 20 mils per segment. 0.30 size character with left decimal. Size 3/4 x 7/16 x 3/16".

LINEAR Op Amps

Part No.	Description	Price
531	Hi slew rate op-amp (TO-5)	\$2.50
532	Micro power 741 (TO-5)	2.50
533	Micro power 709 (TO-5)	2.50
536	PET input op amp (TO-5)	2.50
537	SN7493 741 (TO-5)	2.50
540	70W pwr driver amp (TO-5)	2.50
550	Precision 723 voltage reg. (DIP)	1.17
555	Timer 2 uSeconds to 1-hr (A)	1.00
556	5 Times faster than 741C	2.50
558	Dual 741 (mini DIP)	3.95
560	Phase lock loops (DIP)	3.25
561	Phase lock loops (DIP)	3.25
562	Phase lock loops (DIP)	3.25
565	Phase lock loops (A)	3.25
566	Function generator (A)	3.25
567	Tone generator (A)	3.25
595	Four quadrant multiplier	3.10
702C	Hi-grain, DC amp (TO-5)	.49
703C	RF-IF, amp, 14 ckt (TO-5)	1.00
709C	Operational amp (A)	.49
709C	Op amp (mini DIP)	.49
710C	Differential amp (A)	.49
711C	Dual diff. comp (A)	.49
723C	Voltage regulator (A)	.95
741C	Frequency compensator 709 (A)	.49
741C	Freq. comp 709 (Mini DIP)	.49
747C	Dual 741C (A)	1.25
748C	Freq. adj. 741C (A)	.49
748CV	Freq. adj. 741C (mini DIP)	.44
709-709	Dual 709C (DIP)	1.00
735-739	Dual stereo preamp	1.95
741-741	Dual 741C (A)	1.25
	(A) TO-5 or DIP dual in line pak	1.00

HOT MOS FETS

- 2-MOS FETS, N channel 10k ohms 3N128, TO-18, RCA \$1
- 2-MOS FETS, DUAL GATE, N chan., 3N187-1, TO-18, \$1
- 2-MOS FETS, DUAL GATE, N chan., 3N140-1, TO-18, \$1

NATIONAL EQUALS ON 'DIGITAL CLOCK on a CHIP'

*Money Back Guarantee! Any 'Chip' *With Spec Sheet! **\$12.88**

Mfrs #	Description	Sale
5311	26-pin, ceramic, any readout, 6-digits: A-B-D	\$12.88
5312	24-pin, ceramic, any readout, 4-digits: C-D	\$12.88
5313	28-pin, ceramic, any readout, 6-digits: A-C	\$12.88
5314	24-pin, plastic, LED and incandescent readouts, 6-digits: A-B	\$12.88

Code: A—Hold Count. C—1 PPS Output. B—Output Strobe. D—BCD

LED MITY DIGITS "DCM'S"

Will outperform any other DCM on the market today, not gaseous, not incandescent, but a device that will READ most for life. MAN-4, Monsanto equal. Kit includes: 3 x 2" printed ckt board, with fingers tool. Side-mounting socket, MAN-4 resistors, 7448, 7475, 7490, booklet.

INCLUDES P.C. EDGE CONNECTOR — FREE!

POLY PAKS

P.O. BOX 942H LYNFIELD, MASS. 01940

Advertisers check-off

... for literature, in a hurry — we'll rush your name to the companies whose names you "check-off"

INDEX

- Amtech
- Andy
- Arizona Semi
- Babylon
- Barry
- Bauman
- CFP
- Bitcil
- Carvill
- Comdata
- Command
- Communications Specialists
- Curtis
- Data
- Drake
- Dynamic Electronics
- Ehrhorn
- Eimac
- Epsilon
- Evans
- Exceltronics
- Gateway
- Goldstein's
- Gray
- Great American
- H & L
- HAL
- Heath
- Henry
- Hobby
- Hy-Gain
- Icom
- IN-X
- International Crystal
- Jan
- Janel
- K. E.
- KLM
- KRP
- KW
- L. A.
- Larsen
- Logic
- MFJ
- Madison
- Matric
- Meshna
- Micro-Z
- Midland
- Mor-Gain
- Nurmi
- Pagel
- Palomar
- Pemco
- Poly Paks
- RP
- Racom
- Callbook
- Regency
- Savoy
- Signal Systems
- Solid-State
- Space-Military
- Spectrum
- Standard
- Swan
- Syntec
- Teco
- Ten-Tec
- Tobel
- Topeka FM
- Tri-Ex
- Tri-Tek
- Trionyx
- Tristao
- U-J
- VHF Engineering
- Weinschenker
- Wilson
- Wolf
- World QSL
- Y & C
- Yaesu

Limit 15 inquiries per request.

August 1973

Please use before September 30, 1973

Tear off and mail to
HAM RADIO MAGAZINE — "check off"
 Greenville, N. H. 03048

NAME.....

CALL.....

STREET.....

CITY.....

STATE..... ZIP.....

Advertisers iNdex

ATV Research	92
Amtech	86
Andy Electronics, Inc.	82
Arizona Semi-Conductor	66
Babylon Electronics	73
Barry	83, 96
Bauman	74
CFP Enterprises	80
CTG Bitcil	73
Carvill International Corp.	76
Comdata, Division of ISC	65
Command Productions	88
Communications Specialists	80
Curtis	92
Data Engineering, Inc.	57
Drake, Co. R. L.	95
Dynamic Electronics, Inc.	66
Ehrhorn Technological Operations, Inc.	1
Eimac, Div. of Varian Assoc.	Cover IV
Epsilon Records	92
Evans Radio	73
Exceltronics Research Labs	74
G & G Radio Supply Co.	74
Gateway Electronics	88
Goldstein's	72
Goodheart Co., Inc. R. E.	92
Gray Electronics	90
Great American Miniatures	68
H & L Associates	66
HAL Communications Corp.	67
Heath Company	61
Henry Radio Stores	Cover III
Hobby Industry	84
Hy-Gain Electronics Corp.	39, 70, 71, 79
Icom	77
IN-X Sales	88
International Crystal Mfg. Co. Inc.	69
Jan Crystals	90
Janel Labs	74
K. E. Electronics	92
KLM Electronics	80
KRP Electronic Supermart, Inc.	89
KW Electronics	82
L. A. Electronix Sales	48, 49
Logic Newsletter	66
MFJ Enterprises	90
Madison Electronics Supply, Inc.	88
Matric	68
Meshna, John, Jr.	76
Micro-Z Company	92
Mor-Gain, Inc.	88
Nurmi Electronic Supply	91
Pagel Electronics	90
Payne Radio	72, 78
Palomar Engineers	82
Pemco, Inc.	92
Poly Paks	93
RP Electronics	86
Racom Electronics, Inc.	90
Radio Amateur Callbook	74, 78
Regency Electronics, Inc.	5
Savoy Electronics	Cover II
Signal Systems	86
Solid State Systems, Inc.	81
Space-Military Electronics	90
Spectrum International	56
Standard Communications Corp.	45
Swan Electronics	2
Syntec, Inc.	82
Teco Electronics	68
Ten-Tec, Inc.	76
Tobel Electronics	88
Tri-Ex Tower Corp.	17
Tri-Tek, Inc.	80
Trionyx Electronics	82
Tristao Tower Co.	66
U-J Industries	80
VHF Engineering, Div. of Brownian Elect. Corp.	72
Weinschenker, M.	87
Wilson Electronics	86
Wolf, S.	86
World QSL Bureau	88
Y & C Electronics	66
Yaesu Musen USA Inc.	75

NEW DRAKE TR-72

2-Meter FM Transceiver



- 23 Channels
- Superior Selectivity
- Completely Solid State

\$299⁹⁵

Including dynamic microphone, DC power cord, mobile mount and desk mount brackets, microphone hanger, auxiliary connector, and external speaker plug

GENERAL: • Frequency coverage: 144-148 MHz • 23 channels, 2 supplied (.52/.52 and .34/.94) • Completely solid state • Current drain: Rcv 0.4 A, Xmit 2.7 A (Hi power) or 1.2 A (Lo power) • Voltage required: 13.8 VDC • Antenna impedance: 50 ohms • Frequency adjusting trimmers on every crystal • Size: 7 $\frac{1}{8}$ "W x 2 $\frac{3}{8}$ "H x 9 $\frac{1}{8}$ "D (18 x 6 x 24 cm) • Weight: 5 $\frac{1}{2}$ lbs. (2.5 kg).

TRANSMITTER: • RF output power: 10 W min. (Hi power) or 1 W (Lo power) at 13.8 VDC • Frequency deviation: adjustable to ± 15 kHz max., factory set to ± 6.5 kHz • Automatic VSWR protection

RECEIVER: • Crystal-controlled, double conversion superhet • Sensitivity: Less than .35 μ V for 20 dB quieting • Selectivity: 20 kHz at -6 dB (± 30 kHz and adjacent channel rejection at least 80 dB down) • Audio output: 1 W • Audio output impedance: 8 ohms • Modulation acceptance: ± 7 kHz • Image rejection: -65 dB • Intermodulation and other spurious responses: at least 70 dB down.



For complete details contact:

R. L. DRAKE COMPANY

540 Richard St., Miamisburg, Ohio 45342
Phone: (513) 866-2421 Telex: 288-017

AC-10 POWER SUPPLY
for 115 VAC operation
\$39.95

BARRY HAS ANTENNAS

BN86 Balun by HyGain \$ 14.95
 NEW ULTRA BALUN 1:1 \$ 9.95
 C.D. HAM "M" ROTATORS, new, complete \$99.95
 HAM "M" CABLE @ 13¢/ft.
 CABLE FOR TR-44 6¢/ft.
 RG-8A/U 100 ft. rolls, VHF connector PL-259
 one end Type "N" (UG-21E/U) other end \$ 12.50
 RG8A/U — 65 feet with PL-259 connectors on
 each end \$9.50
 B & W Vacationer apartment house antenna, 2,
 6, 10, 15 & 20 meters. Hang out your window.
 Take along on your vacation \$ 24.95
 Authorized factory dealers for Antenna Special-
 ists, CushCraft, Gam, Heights Towers, Hy Gain,
 Mor-Gain Antenna, Mosley, Newtronics, Tri-Ex,
 Rohn, E-Z Way, Times Wire

C.D. TR-44 ROTATORS, new, complete \$63.95
 Cush-Craft Trick Stick, universal dipole, 10-2
 meters, 1.5 dB gain at 146 MHz \$ 8.95
 English deluxe balun, low power \$ 9.95
 RINGO AR-2 3.75 dB gain \$ 12.50
 BBLT-144 Trunk Lip, 3.75 dB gain \$ 34.95
 Newtronics CGT-144 mobile 5.2 dB gain \$ 37.75
 Quick Disconnect by Newtronics for CGT, etc.
 \$ 9.95
 CG-1 Gutter Clip by Newtronics \$ 1.25
 2M MAGNETIC MOUNT w/RG58 & PL259
 with 10 ft. RG 58 ready to go \$ 9.95
 14AVQ/WB VERTICAL \$ 47.95
 18AVT/WB VERTICAL \$ 69.95
 HY GAIN 2 METER, 15 element beam \$ 35.00

INVERTER/CONVERTER:

INVERTER, 12 volt DC input, 115 volt AC out,
 Model 12-115 solid state power supply, 200
 watts continuous new, \$ 59.95



GE INDUSTRIAL SILICON RECTIFIER 1400 PIV

250 amp., GE #41A281049-11. Quan-
 tities in stock. \$90.00 value, brand
 new \$22.50

BIRD

4350 80-10M 2KW Ham Mate \$ 79.00
 43 Wattmeter \$100.00
 BIRD 43 SLUGS, spec. freq./power, HF
 VHF, \$32.00 ea.

MISC.

Lafayette Telsat-SSB 25, Sideband CB Rig Write
 Heathkit HW-17 with Heath FM Adapter Write
 Gonset 900A 2 meter Sidewinder with 901A AC
 power supply. 144-148 MHz SSB, AM & CW.
 20w. PEP, 6w. AM mint, \$250.00
 Gonset 903A 2 meter amplifier, 5 watts in, 500
 watts out all modes \$375.00
 HQ-180 with clock. Mint condition, professionally
 calibrated. Needs new RF gain control \$275.00
 Millen magnetic shields for 3" C.R. scope tubes
 with brackets. Brand new \$ 6.95
 TP-9 Similar to EE-8 field telephone with built-
 in amplifier. Up to 50 mi. Less easily obtained
 batteries Brand New \$ 75.00
 Power Supply for BC-221, slips into battery com-
 partment \$29.50
 ALUMINUM DIE CAST BOXES in many different
 sizes. Dossy boxes. Details in New Green Sheet
 No. 23.



Jackson G80 brass 50:1 anti-back-
 lash dial drive 1/4" to 1/4". \$19.00
 value \$5.50

2 METER VHF DUMMY LOAD/WATTMETER
 Good up to 15 watts — w/SO-239 CONNECTOR
 \$19.95

Separate export department to expedite
 overseas orders.

BARKER & WILLIAMSON

Dummy Load - Wattmeters - 52Q
 333 DC - 300 MHz, 1000 watts int. \$139.95
 334A DC - 230 MHz, 1500 watt \$169.95
 374 DC - 300 MHz, 250 watt int. \$ 79.95
 850A, 852 Inductors \$ 59.95
 851 Inductor \$ 29.95
 425 Low Pass Filter, 10-80 meters \$ 24.95
 120 Audio Osc., ideal for lab & broadcast
 \$329.95
 410 Distortion Meter, ideal for lab & broadcast
 \$369.95
 AM-141 Amplifier, 2000 watts RF output, con-
 tinuous 2-18 MHz, complete with coils and
 833-A's. Built-in 115 VAC Supply, unused
 \$950.00

Builders. See the nifty Aluminum Die
 Cast Boxes in Barry's Green Sheet.
 Many different sizes. Also Dossy boxes.

E. F. JOHNSON

Matchbox complete with directional coupler and
 indicator, 10-80 meters.
 2KW PEP, 1 KW AM — new, \$154.50
 275 watts — new, \$ 94.95
 151-1-4 Variable Capacitor, 250 pF, medium
 Xmitting type \$2.95 ea.

Tube Headquarters. Diversified Stock.
 Huge inventory of Eimac tubes,
 chimneys, sockets, etc.

572B \$ 17.50
 Barry Now Stocks Bogen, Electrovoice & Univer-
 sity. Call or Write.

CASH PAID . . . FAST! For your unused TUBES,
 Semiconductors, RECEIVERS, VAC. VARIABLES,
 Test Equipment, ETC. Write or call Now! Barry,
 W2LN1. We Buy!

We ship all over the World.

Send for Green Sheet Supplement 23.
 Send 10¢ plus 40¢ postage & handling
 (refund 1st order).

SWR BRIDGE COUPLER, DC-800 MHz

(no indicator) full amateur power
 \$90.00 Value
 \$10.95

BARRY 512 Broadway NY, NY 10012
 DEPT. H-8
 212-WA-5-7000 **ELECTRONICS**

See Page 83 for more from Barry

amateur radio's new standard of excellence

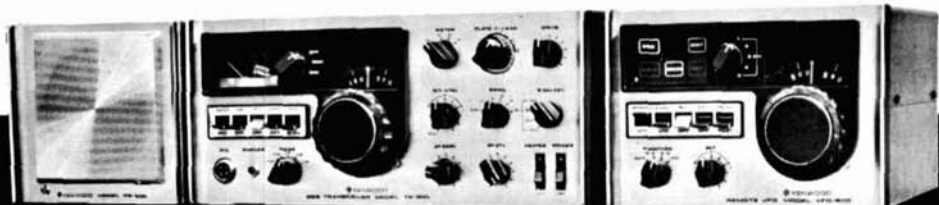

KENWOOD'S SUPERB NEW SOLID STATE SSB TRANSCEIVER

TS-900

FEATURES: • Break-in CW with sidetone • Built-in 100 KHz and 25 KHz crystal oscillator • Built-in RIT and RIT indicator light • Built-in RTTY frequency shift for FSK • Built-in noise blanker • Built-in VOX • Modular construction — repair in or out of equipment • RF AGC to prevent front end overload to strong signals • Completely solid state except final section • 1 KHz readout

GENERAL SPECIFICATIONS: Frequency Range: 3.5 - 30 MHz Amateur Bands and WWV • Mode: SSB, CW, or FSK • Power Output: 150 watts PEP nominal into 50 ohms for SSB, 100 watts nominal into 50 ohms for CW, 50 watts nominal into 50 ohms for FSK • Frequency Stability: Within 100 Hz during any 15 minute period after warmup. Within ± 2 KHz during the first hour after 1 minute of warmup • Receiver Sensitivity: 0.5 microvolts for a 10 db (signal + noise)/noise ratio • Receiver Selectivity: SSB and FSK — 2.2 KHz bandwidth (6 db down), 4.4 KHz bandwidth (60 db down), CW — 0.5 KHz bandwidth (6db down), 1.5 KHz bandwidth (60 db down), (with optional CW filter installed) • Dimensions: 12.6" wide • 5.5" high • 12.6" deep • Weight: 26.5 pounds (32.5 pounds shipping weight) • Price: TS-900 \$795.00, PS-900 (AC Supply) \$120.00, DS-900 (DC Supply) \$140.00, VFO-900 (Remote VFO) \$195.00.

THE KENWOOD R-599 RECEIVER ... 1.8 to 29.7 MHz (Amateur Bands) • Dial readout to ½ KHz • Special detectors for SSB, AM, and FM • Transceive operation with T-599 • Built-in 100 KHz and 25 KHz calibrators • Built-in 500 cycle CW filter • Provision for 2 meter and 6 meter coverage with accessory self-contained converters • 120/240 VAC or 12 VDC operation • All solid state • R-599 — \$389.00 Converters — \$31.00 S-599 Speaker — \$16.00.

THE KENWOOD T-599 TRANSMITTER ... Clear, stable, selectable sideband, AM and CW • 4-way VFO flexibility plus RIT when used with the R-599 • Amplified ALC • Built-in VOX • Full metering • Built-in CW sidetone monitor and semi-automatic break-in CW • Built-in power supply for 120/240 VAC operation • Only 3 vacuum tubes • 200 watts PEP input nominal • Full amateur band coverage (3.5 to 30 MHz). T-599 — \$429.00

✓ NOTE: The TS-511S still sells for the same low price... still the same high quality

THE KENWOOD TS-511S TRANSCIEVER ... a powerful five band transceiver (3.5 to 30 MHz, amateur bands) for operation on SSB and CW • Built-in VOX • Built-in crystal calibrator • Built-in noise blanker • Receiver Incremental Tuning (RIT) • 1 KHz frequency readout • Eight pole filter • Exceptional stability • Provisions for installation of an accessory high selectivity CW filter • 500 watts PEP input for SSB • 5 µv sensitivity nominal • Full metering — Cathode current (IP), plate voltage (HV), ALC, and relative power output (RF) as well as an S-meter • Amplified ALC • Heavy duty 120 VAC external power supply. TS-511S — \$415.00 PS-511S — \$105.00 VFO-55S — \$105.00 CW-1 — \$39.00

Prices subject to change without notice

EASY FINANCING • 10% DOWN OR TRADE-IN DOWN • NO FINANCE CHARGE IF PAID IN 90 DAYS • Good RECONDITIONED EQUIPMENT • Nearly all makes and models. Our reconditioned equipment carries a 15 day trial, 90 day warranty and may be traded back within 90 days for full credit toward the purchase of NEW equipment. Write for bulletin. Export inquiries invited.

TED HENRY (W6UOU)

BOB HENRY (W0ARA)

WALT HENRY (W6ZN)

Henry Radio

11240 W. Olympic Blvd., Los Angeles, Calif. 90064 213/477-6701
931 N. Euclid, Anaheim, Calif. 92801 714/772-9200
Butler, Missouri 64730 816/679-3127



This is the world's most powerful shortwave transmitter.

This compact, single tube amplifier, located in the EIMAC facility, develops over 1300 kilowatts of 100% modulated carrier. It is quickly and easily tunable over the range of 15 to 30 MHz. Drive power at the grid of the tube is less than 5 kilowatts.

Using a single EIMAC X-2159 super-power tetrode in a Continental Electronics transmission line-cavity configuration, this amplifier combines high power gain with excellent operating stability and complete freedom from circuit parasitics.

A single amplifier stage using two EIMAC X-2159 tubes is capable of over 2.5 megawatts of 100% modulated

carrier. Two amplifiers combined would make a 5 megawatt transmitter a practical reality.

The EIMAC X-2159 super-power tetrode is designed for MF and HF broadcast service, VLF communications, SSB linear service and extremely high power pulse modulator applications.

The X-2159 is another example of tomorrow's tube that's ready today at EIMAC. For complete information, contact EIMAC Division of Varian, 301 Industrial Way, San Carlos, California 94070. Or any of the more than 30 Varian/EIMAC Electron Tube and Device Group Sales Offices throughout the world.

division
varian